

2022

SIDING COLLECTION

Vinyl & Polymer Siding, Stone Veneer, Trim,
Accessories and Railing Products

Welcome to the 2022 CertainTeed Siding Collection

Higher Standards

Higher Standards and Greater Rewards are about the many

This starts with a comprehensive array of exterior products that allow your customers to express their unique personal style. CertainTeed products deliver higher standards in selection, beauty and performance.

In fact, CertainTeed offers the broadest selection of exterior products, styles and colors to achieve a full range of design options. No other company can match CertainTeed's portfolio of products. With all our products we offer freedom of choice for your customers to experiment with style, color and texture... the freedom to be creative, to mix and match and think beyond just four walls. Your customers will appreciate that you are providing them with the products and expertise to achieve their vision – no matter what their vision may be.

For you, higher standards mean focusing our extensive industry experience to help you navigate the challenging construction market. We pledge to support you with educational opportunities, contractor certification, rebate programs and comprehensive marketing tools that empower you with the knowledge and confidence to outpace your competition. Look to CertainTeed as your trusted partner for making a positive and lasting impression on every customer you meet.

Why CertainTeed 4

Choosing the
Right Products 8

2022 Highlights 10

Info Key 16

On Cover:

Siding: STONEfaçade stone veneer
in Harbor Sunset and Cedar
Impressions Individual 5" Sawmill
Shingles in Cedar Blend with
Monogram Double 4" in Forest.

Trim: Vinyl Carpentry®
and Restoration Millwork®.

Shakes & Shingles

Cedar Impressions®
Sawmill Shingles 20

Cedar Impressions®
Perfection Shingles 26

Cedar Impressions®
Rough-Split Shakes 32

Northwoods®
Perfection Shingles and
Rough-Split Shakes 36

Stone Veneer

STONEfaçade® 40

Insulated Siding

CedarBoards™/ XL 44

Horizontal & Vertical Siding

Monogram®/ XL 48

Restoration Classic™ 52

Board & Batten Vertical Siding 56

Reverse Board & Batten 58

Carolina Beaded™ 60

MainStreet™ 62

Wolverine American Legend™ 68

Encore™ 70

Greater Rewards

ways CertainTeed helps you differentiate yourself to grow your business.

Earn greater rewards through more opportunities to grow your business by helping customers discover the finest roofing, siding, trim, fence, decking and railing that will transform the appearance of their homes.

Moreover, CertainTeed offers the 5-Star Contractor Program, the premier contractor program in the industry. 5-Star contractors are truly treated as partners. CertainTeed offers industry leading training programs, as well as sales, marketing and business-building tools, to provide contractors with the professional credentials necessary to stand out in today's marketplace. Plus, we make it easy for homeowners to find knowledgeable, skilled and trustworthy professionals through our robust "Find a Pro" website tool. No other program is as extensive or more focused on partnering with contractors for success.

At CertainTeed, we understand that our success is tied directly to your success.

Soffit / Porch Panel

Triple 3-1/3".....	72
Perimeter™ Triple 3-1/3".....	72
Beaded.....	72
Ironmax™.....	74
Universal.....	74
Value.....	75

Trim

Vinyl Carpentry®.....	76
Restoration Millwork®.....	78
Finishing Touches.....	80

Underlayment

CertaWrap™.....	82
-----------------	----

Complementary Products

EverNew® Railing.....	84
-----------------------	----

Colors shown throughout this brochure are as accurate as printing methods will permit. Please see product samples before making final selection.

Why CertainTeed?

Trust

Professionals agree, CertainTeed still leads the Vinyl and Polymer Siding industry

For the 25th year in a row, builders and contractors named CertainTeed Vinyl Siding Number One in the categories: Brand Familiarity; Brands Used in the Past Two Years and Brands Used Most in the 2021 Hanley-Wood Brand Use Study.



CertainTeed offers an industry-leading spectrum of colors including unique darker shades and semi-transparent stained colors for virtually unlimited design possibilities.

Utilizing the newest technology and state-of-the-art formulations, CertainTeed backs their vinyl siding with PermaCOLOR Lifetime Fade Protection.

Warranty

Simply put, if our product fails due to a manufacturing defect, we will stand behind it. To obtain a copy of our complete warranty go to www.certainteed.com

Service

Local Manufacturing

CertainTeed's vinyl and polymer building products are shipped from one of seven manufacturing facilities throughout the United States, ensuring that you are rarely more than 500 miles from a factory location.

Professional Distributors

Our strong network of local distributors enables you to rest easy knowing that you will have complete access to CertainTeed's full line of exterior products.

Experienced Territory Managers

With over 250 territory managers across North America, it is easy to find a CertainTeed representative who can assist you in growing your business.

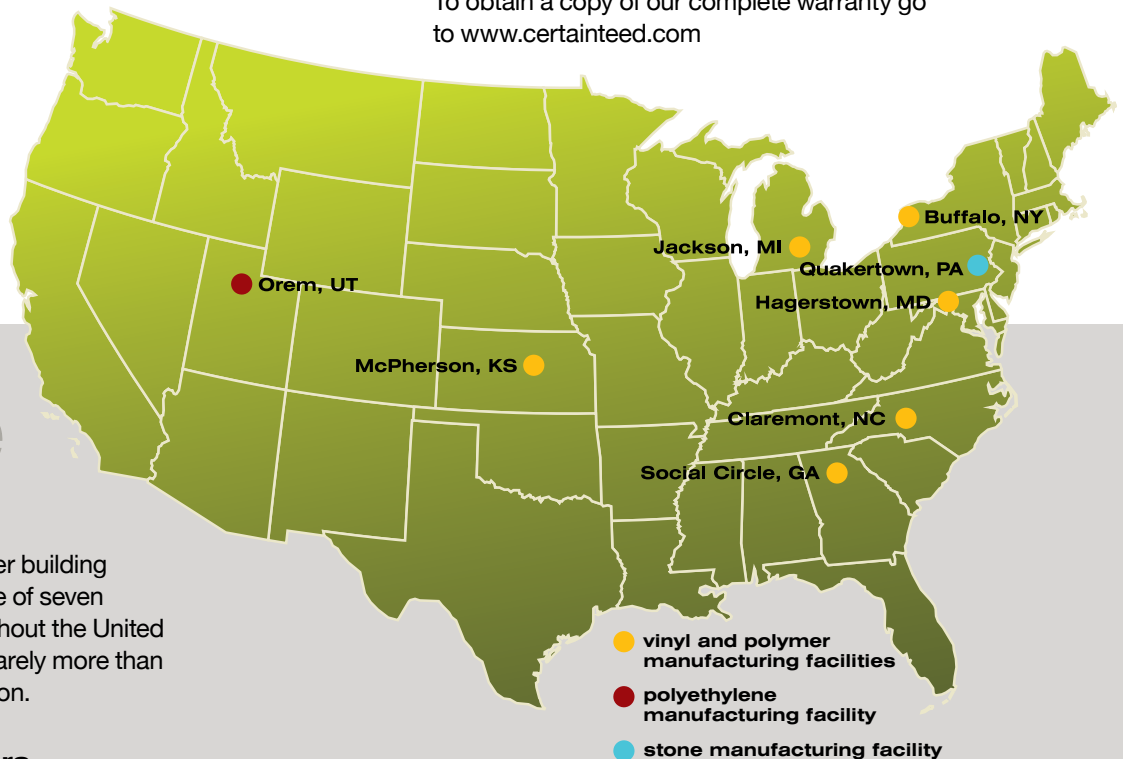

Mobile Training Vehicles

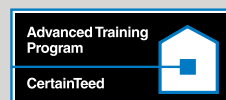

Expert Training and Education

Each year CertainTeed travels across North America putting on over 200 local training programs designed to help you increase your skills, capabilities and profit potential.

Mix & Match

Benefit from the power to mix & match products, styles and colors

CertainTeed's complete selection of exterior product options are tailor-made to take creative advantage of the exciting mix-and-match approach to exterior home design – combining various products, styles and colors to create truly unique exterior designs.

Using combinations of horizontal and vertical siding plus shakes and shingles together makes a bold statement. Adding soffit and trim delivers just the right accent. All choices coordinate perfectly with roofing, fence, decking, and railing options for a complete package. The collection allows your customers to rely on a single, trusted source for virtually every exterior product they need – and gives you more opportunities to cross-sell.



SABLE BROWN

COLONIAL WHITE

SAVANNAH WICKER

APPALACHIAN TWILIGHT

AUTUMN RED

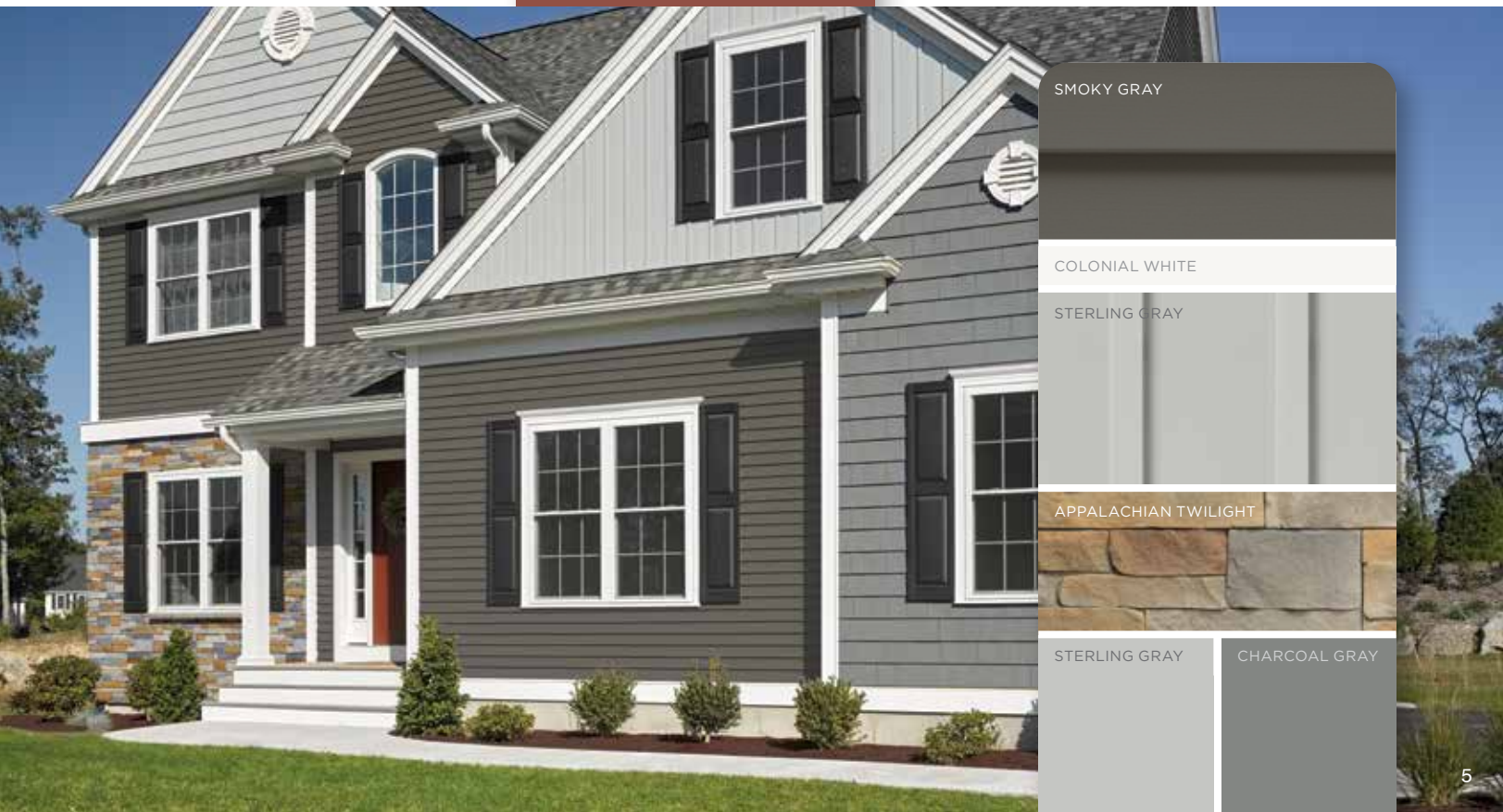

SMOKY GRAY

COLONIAL WHITE

STERLING GRAY

APPALACHIAN TWILIGHT

STERLING GRAY

CHARCOAL GRAY

Why CertainTeed?

Color Leadership

Together, siding, trim and roofing color selection has a profound impact on the overall look of a home's exterior. Siding and trim colors cover the exterior walls for curb appeal, but this also extends to the roofline, on what one architect calls a home's "fifth façade."

CertainTeed's color alignment simplifies the task of combining siding and roofing with other facets of the overall design, like decking, railing and fence, to create a cohesive look. From warm and inviting to cool and fresh, there are color palettes to satisfy every preference. All our products deliver the craftsmanship, durability and virtually maintenance-free performance your customers expect from CertainTeed.

ColorView® offers users the ability to mix and match colors and styles on a wide variety of pre-populated home styles to get design ideas.

ColorView DIY lets users who are short on time begin designing today – upload a project picture and in just a few minutes you can mix and match colors and styles on your own project.

ColorView Pro gives users the opportunity to have a photo of their home professionally masked in just a few days for them to use in ColorView Online.

ColorCoach™ is a simple web-based tool that acts as a virtual color swatchbook for consumers. It also helps contractors and builders recommend CertainTeed roofing, siding, and trim color combinations that look great together.

EverView® The easy mix-and-match EverNew® railing Tool. Try out railing and baluster combinations by choosing from an industry leading palette of colors and products, then finish it off beautifully with your choice of caps and lights.

Blend-it™ view how Cedar Impressions Ageless Cedar™ Color Blends look on a home to help one choose a one-of-a-kind design.

Fence-it® allows users to envision different Bufftech® fence heights, styles and textures on the fly, in a simulated outdoor environment. Find the perfect color from an industry leading palette.



Start exploring all of CertainTeed's color tools now at certainteed.com/colortools

Innovation

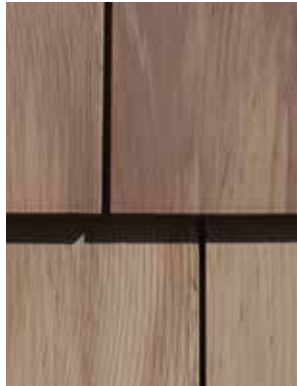

Ageless Cedar™ Color Blends
The beautiful colors and shades of Cedar Impressions Ageless Cedar Color Blends are an integral component of the siding. Unlike competitive products that have color applied only on the surface, CertainTeed's proprietary, patent-pending manufacturing process results in blended color through the entire shingle. The result is an authentic, blended-wood look.

Color matching Ageless Cedar Color Blends now available in Monogram siding line. (See page 12-13 for more info.)

TrueTexture™
CertainTeed was the first to produce siding utilizing a direct transfer system from real cedar boards, shingles and shakes to create natural TrueTexture finishes. The look of true wood craftsmanship can be created when combined with CertainTeed's Vinyl Carpentry® and Restoration Millwork®.

Installation Features
Many engineering innovations including the PanelThermometer, HammerTapper and StudFinder make CertainTeed Siding the industry leader.

COOLBACK™ COLOR TECHNOLOGY

CertainTeed continues to lead the industry by introducing CoolBack™ Technology for all CertainTeed vinyl siding and soffit panels. CoolBack's proprietary formulation is engineered to enhance panel performance.

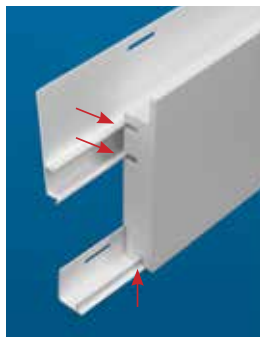
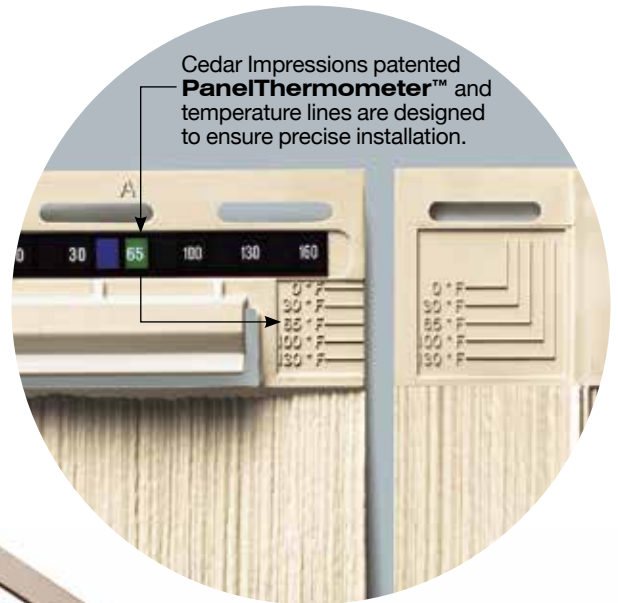

INhanced® TRIM LINE
INspired designs that enhance aesthetics. INnovative engineering that improves performance. INtegral components that speed installation. That's the power and promise of the INhanced® Trim Line from Restoration Millwork.



STUDfinder™
Designed to help ensure a safe, precise installation for maximum siding performance.



Choosing the right products for your project.

Curb Appeal™ That Lasts

CertainTeed offers an industry-leading selection of low-maintenance products that create beautiful, timeless looks that last.

Authentic from the curb or close up

From historic to modern to timeless, each project has its own unique design challenges. CertainTeed's wide variety of styles and textures empower you to select the product that will deliver the architectural accuracy and beauty required to meet every project's needs.



Industry leading color palette

CertainTeed's color palette simplifies the task of combining siding and roofing with other facets of the overall design, like decking and fence, to create a cohesive look. From warm and inviting to cool and fresh, there are color palettes to satisfy every preference. Backed by PermaColor™ Lifetime Fade Protection, our products deliver the virtually maintenance-free performance your customers expect.



Details create the personality

The personality of a home is reflected in the unique details of the project. CertainTeed offers a complete selection of virtually maintenance-free accent and decorative trim accessories designed to complement any project.



Reimagined Outdoor Living Spaces

The comforts of home are no longer defined by four walls. Outside spaces are “in” as porches, yards and gardens are transformed into beautiful open-air rooms. If you are longing for the joys of fresh air living, CertainTeed can help.



Create a great outdoor room

Use CertainTeed’s innovative exterior products to transform unused areas into new Living Spaces. Adding a great outdoor room that is full of rich details creates new areas for entertaining or leisure.



Define outdoor spaces with natural textures

Fence, decking and railing products help define new outdoor living spaces. CertainTeed’s selection of authentic textures and colors act as a part of the landscaping to create a beautiful aesthetic in any yard.

For more information on CertainTeed outdoor living products visit certainTeed.com



2022 Highlights: New Product and Color Releases



COMING
SOON

Reverse Board & Batten Reinforced Siding

Reverse Board & Batten Reinforced Siding is a unique profile that can be used alone or with a combination of other siding styles on the home. The narrow boards and wide battens offer a rustic appearance that could only be achieved with real wood in the past.

Page 58





Siding: Reverse Board & Batten Single 7" Reinforced Vertical Siding in Sterling Gray and Monogram Double 4" Clapboard in Flagstone.
Trim: Vinyl Carpentry® & Restoration Millwork®.

2022 Highlights: New Product and Color Releases



Cedar Impressions®



Cedar Impressions is introducing several new colors to T5" Straight Edge Sawmill Shingles and D7" Straight Edge Perfection Shingles.

Page 20 and 26

Cedar Boards

S12" Board & Batten

Adding to the Cedar Boards S12" Board & Batten color line, new for this year are snow and herringbone.

Page 44



Board & Batten

S7"

Coming soon, four new rich colors will increase the dark range of colors in Board & Batten including the all new tuxedo.

Page 56



Board & Batten

S8"

Snow is now available for Board & Batten S8"

Page 56



2022 Highlights: New Product and Color Releases

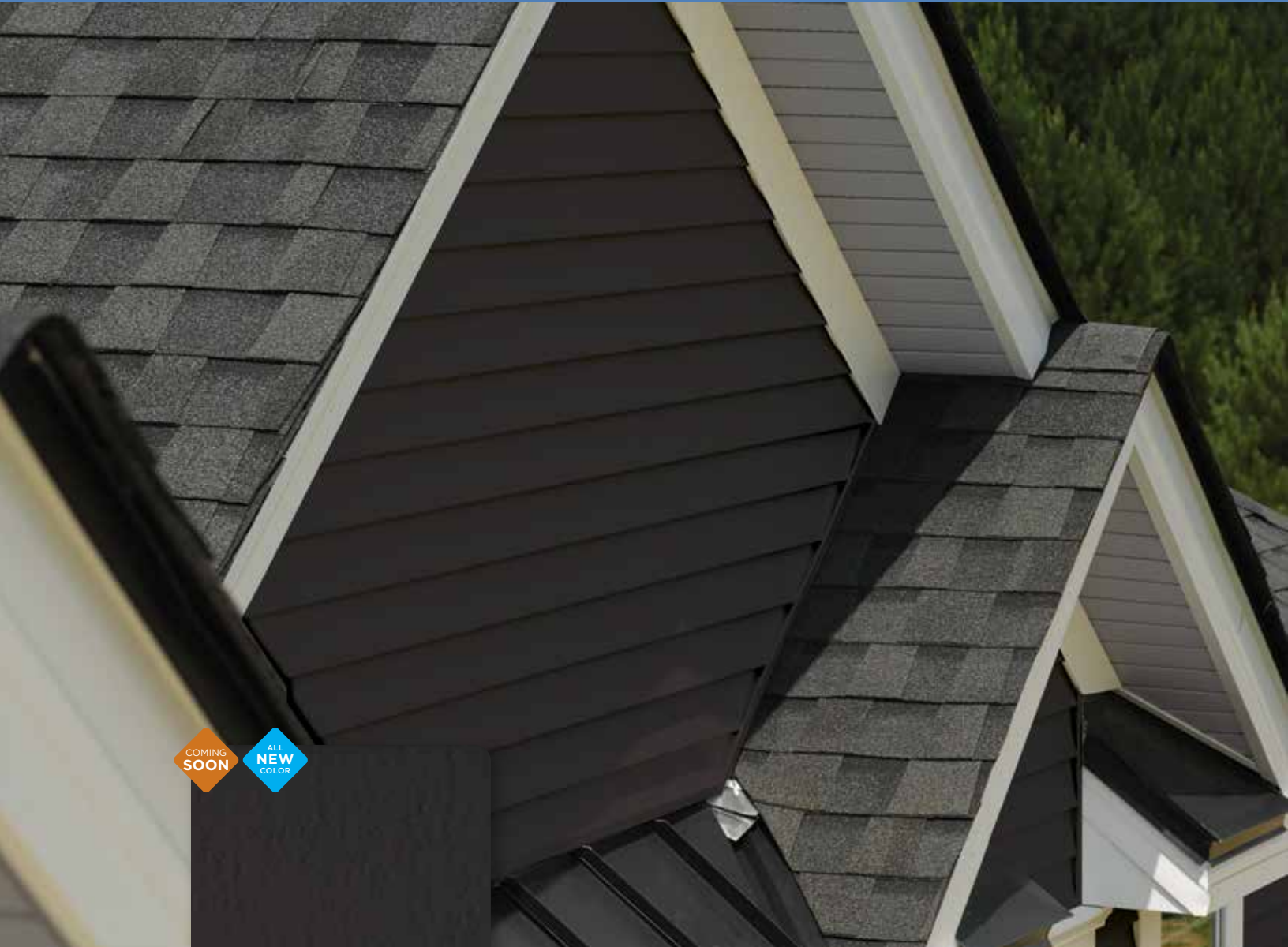

COMING SOON
ALL NEW COLOR

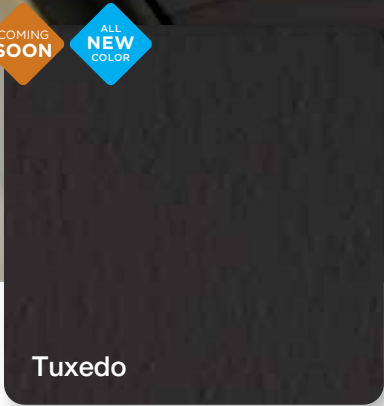

Tuxedo



Smoky Gray



Olive Grove

Monogram[®]

Monogram D4" Clapboard, D5" Clapboard and D5" Dutchlap receive three new colors, including tuxedo which is all new to the CertainTeed family of colors.

Page 48

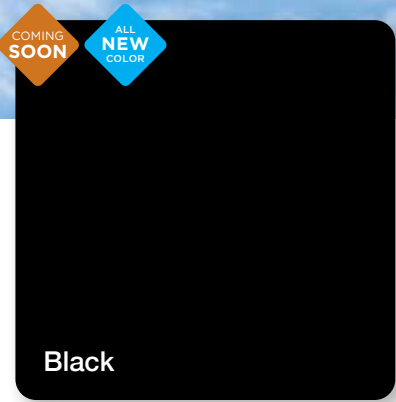

COMING SOON

ALL NEW COLOR

Black

Universal T4"

Soffit & Vertical Siding

Black is all new to CertainTeed and will be added to Universal T4" Soffit and Perimeter Triple 3-1/3".

Page 74

Perimeter Triple 3-1/3"

Soffit & Vertical Siding

Introducing two new low-gloss, soffit and vertical siding colors in black and herringbone.

Page 72



NEW COLORS

Herringbone



COMING SOON

ALL NEW COLOR

Black

Icon Guide

Below you will find an explanation of each icon used for easy reference to identify and compare the many product features, benefits and specifications of the siding products offered by CertainTeed.

Aesthetics



Colors:

Shows the number of different colors available within each product line. The CertainTeed Siding Collection features solid colors that replicate the look of freshly painted cedar and variegated blends which provide the appearance of semi-transparent stained finish.



Extended Lengths:

Indicates products that are available in extended lengths, including 16', 20' and 25'. Longer length siding significantly reduces the number of seams when panels overlap horizontally, increasing the overall aesthetics of the wall.



Panel Projection:

Identifies the full depth of a siding panel as measured from the back of the panel to the tip of the front of the panel. Deeper panel projections add rigidity to siding products while providing wider shadow lines that enhance aesthetics. This measurement is also used for proper sizing of accessories necessary to install the siding.



Profiles:

Lists the number of different profiles available within each product line. A profile is the contour or outline of a panel as viewed from the side or end. Product profiles, such as ledgerstone, clapboard and dutchlap, are designed to mimic the different architectural styles of wood or stone cladding products.



Texture:

Indicates available textures within each product line. Whether you are seeking the smooth appearance of milled cedar, authentic stone look, or one of the many TrueTexture™ woodgrains molded from real cedar boards, CertainTeed offers a wide array of architecturally authentic product textures to choose from.

Installation



Fastener Indicator:

CertainTeed is the only siding engineered to include an integral fastener placement guide on each panel. The Patented STUDfinder™ Installation System and Cedar Impressions® fastener indicators are designed to help ensure a safe, precise installation for maximum siding performance.



Lock:

Designates the panel lock design of the product. CertainTeed Siding Products feature proprietary locking designs created to optimize the alignment and installation for each specific product. The special features of CertiLock™ and DuraLock® ensure that every siding panel goes on the wall straight and secure.



No Mortar:

STONEfaçade™ product does not require mortar - making installation clean, quick and easy. A no mortar installation also means special masonry skills are not required.



Panelized:

Each panel features an insert that functions as both rainscreen and reinforcement. Perimeter edges are beveled to hide the substrate for a more attractive appearance.

Performance



Drainability / Moisture Resistance:

Product technology eliminates the common problem of moisture accumulation in wall cavities through the use of innovative materials, rainscreens, weep holes or open designs.



Fade Protection:

CertainTeed offers an industry-leading spectrum of colors including unique, darker shades and semi-transparent stained blends for virtually unlimited design possibilities. Utilizing a unique pigment chemistry, CertainTeed guarantees Lifetime Fade Protection on our vinyl siding.



Fastening Hem Design:

Identifies the type of fastening hem design on a cladding product. Rollovers and / or reinforcing ribs are used to stiffen the nail hem of a siding panel, giving it a straighter appearance on the wall while contributing to the wind load resistance of the product.



Flame Spread Rating:

Indicates products that are Class A Flame Spread Classified, meaning that the material is highly resistant to fire and does not spread flames quickly and/or is self-extinguishing.



Low Maintenance:

Unlike other cladding products that require regular repainting, recaulking, tuckpointing, and sealing to maintain their aesthetics, CertainTeed cladding products can be kept beautiful using a soft bristle brush and a bucket of soapy water.



Panel Thickness:

Defines the average thickness or gauge of a siding panel which is an important element of siding quality. Thicker panels look straighter on the wall, are more durable, and hold up against impacts and high winds. CertainTeed siding products are regularly audited by Architectural Testing, Inc. to ensure they meet or exceed ASTM standards for vinyl siding.



Warranty:

CertainTeed shakes, shingles, insulated, horizontal, soffit and vertical products are covered by a Lifetime Limited Warranty. STONEfaçade products are covered by a 20-Year Limited Warranty.



Wind Load:

This is the rating for the maximum wind pressure that a siding product can withstand. All CertainTeed Siding products* are rigorously tested by Intertek Group plc. to meet or exceed ASTM standards for resistance to negative wind load pressures.

*Products adhere to ASTM D3679, D7793, D7254 standards for capable wind speed ratings based on standard windload design pressure ratings. For most current ratings, please reference www.certainteed.com.

Colors shown throughout this brochure are as accurate as printing methods will permit. Please see product samples before making final selection.

Over 25 Years of *Impressive* Innovations

Generation 2

Introduced multiple new features, including:

- TrueTexture™ realistic wood grain look from real wood cedar shingles
- PanelThermometer™ to indicate the correct panel temperature for precise installation
- Texture added to the butt section of panel
- Hangers and locks were increased to allow for better expansion and contraction
- Improved function of the side tabs for locking
- More styles: Half-Rounds, Triple 5", Rough-Split Shakes in Double 7" and 9"
- Multiple darker colors
- Accessories – outside corners, inside corners, bay corners



1992 – 2003

2004 – 2015

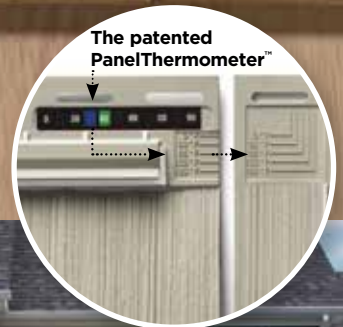

Generation 1

- National launch in 1992
- Double 7" Perfection Shingle, available in 4 colors
- Initially produced as a vacuum-formed product
- First injection molded, vertical woodgrain product for precise duplication of real wood texture



Cedar Impressions®

Polymer Shake & Shingle Siding



Offset corner



HammerTapper™

Continuous nail hem with tape measure



scallop



half-cove

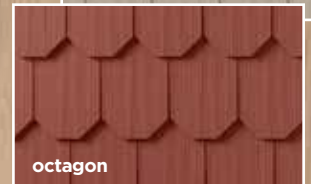

octagon

2016 - current

Generation 3

- Introduced Triple 5" Sawmill Shingles
 - Also introduced Individual 5" Sawmill Shingles and Single 7" Perfection Shingles featuring Ageless Cedar™ color technology color blended throughout the shingle
 - Created offset corner accessories for a more natural installation
 - Launch a refined Double 7" panel
 - Development of new accent shapes: Scallop, Half-Cove and Octagon
 - Introduced solid colors into the Single 7" panel
- Added the following Engineering Enhancements:
- HammerTapper™ - allows easier positioning of the panel - tap to left and tap to right
 - More natural-looking tapered shingle gaps
 - Continuous nail hem (installation friendly - makes it impossible to miss a tab)
 - Nail stop - indentation in nail hem area to prevent driving nails too tight
 - Tape measure on continuous nail hem to help make proper cuts easier



Color Blends

Natural Blend*

Driftwood Blend*

Cedar Blend*

Rustic Blend*



* Balanced mix - premium colors

Cedar Impressions[®]

Sawmill Shingles



- 2
- 41
- up to 300mph
- Reinforced Nail Slots
- 1/2" Panel Projection Individual 5"
- 3/4" Panel Projection Triple 5"
- Sawmill
- CertiLock Triple 5"
- Lifetime Limited Warranty
- Fastener Indicators
- Low Maintenance
- Drainability



Siding: Cedar Impressions Individual 5" Sawmill Shingles in Cedar Blend Balanced Mix.
Trim: Vinyl Carpentry[®] & Restoration Millwork[®].
Roof: Landmark[®] Shingles in Cinder Black.



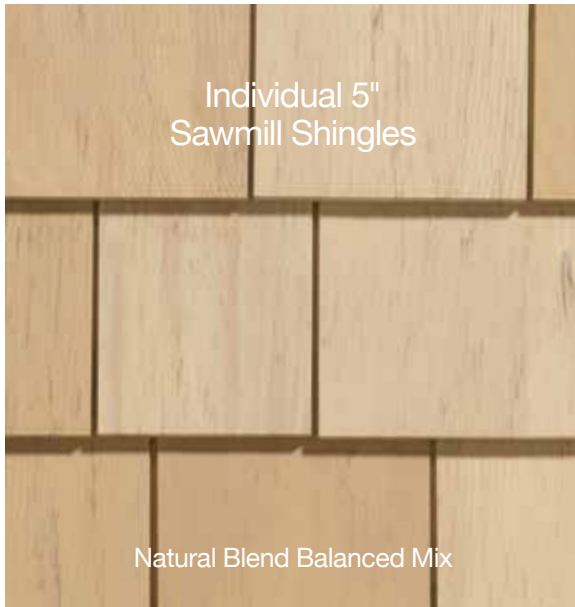

Individual 5"
Sawmill Shingles

Natural Blend Balanced Mix



Individual 5"
Sawmill Shingles

Driftwood Blend Balanced Mix

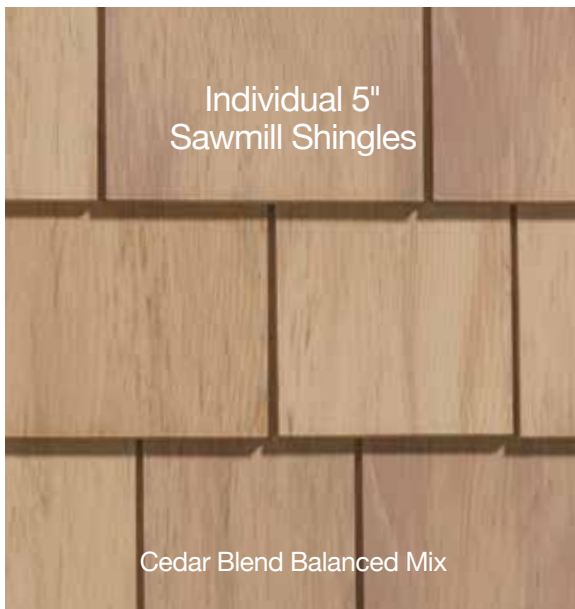

Individual 5"
Sawmill Shingles

Cedar Blend Balanced Mix



Individual 5"
Sawmill Shingles

Rustic Blend Balanced Mix

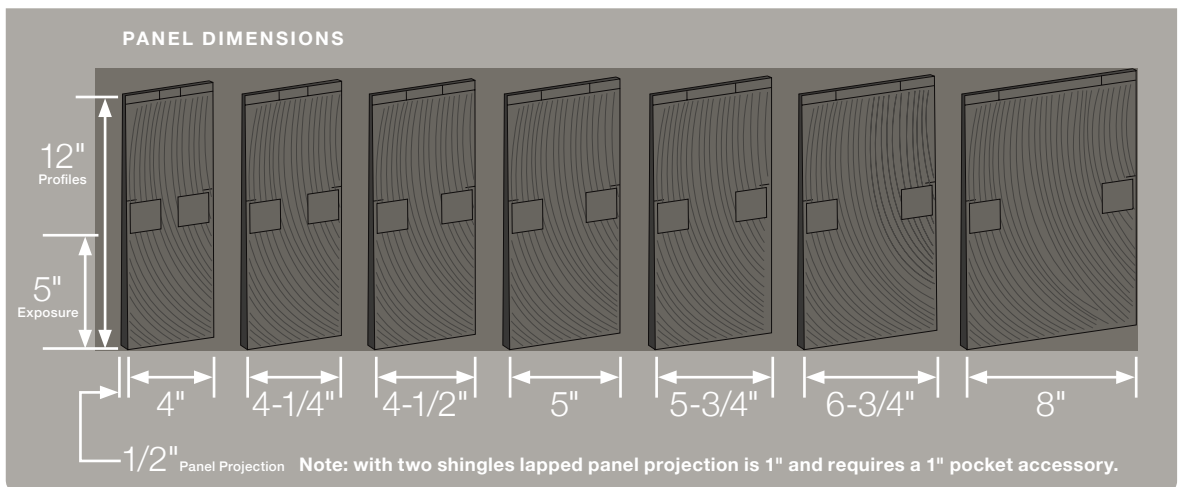

Recommended Trim

CertainTeed recommends the use of Restoration Millwork PVC trim for the most authentic look of genuine cedar. If you choose to use CertainTeed vinyl accessories, the following solid colors are the best comparable options:

- Natural Blend = Buckskin
- Cedar Blend = Cedar Blend Solid
- Driftwood Blend = Granite Gray or Charcoal Gray
- Rustic Blend = Sable Brown

Features of Cedar Impressions Individual Shingles Siding

There are seven different shingle sizes with widths varying from 4" to 8". Shingles are engraved within the staple zone. Shingles are 12" long and require 5" exposure. Installation is made simpler with these easily identifiable features marked on the front of each shingle.

Shingle Gap Zone

Overlapping shingle gap must fall between upper vertical marks and Fastener Target Zones (1-1/2" minimum from shingle edge)

Starter 1/2" Offset

Align with top of first course shingles.

Course Hash Marks

Align marks to top of prior course to assure 5" exposure.

Pre-formed Holes

For hand nailing application



Note: with two shingles lapped panel projection is 1" and requires a 1" pocket accessory.

Fastener Target Zone

Fastener must be applied within the recessed area. 2 fasteners per shingle are required.



Triple 5" Sawmill Shingles



Hearthstone

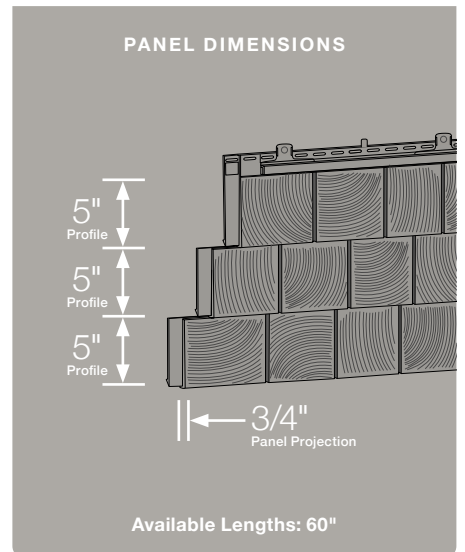

Individual 5" Outside Corner Posts



Triple 5" Outside Corner Posts





	15 Sawmill Shingles	T5 Sawmill Shingles	
Natural Blend – Light**	●		
Natural Blend – Medium**	●		
Natural Blend – Dark**	●		
Driftwood Blend – Light**	●		
Driftwood Blend – Medium**	●		
Driftwood Blend – Dark**	●		
Cedar Blend – Light**	●		
Cedar Blend – Medium**	●		
Cedar Blend – Dark**	●		
Rustic Blend – Light**	●		
Rustic Blend – Medium**	●		
Rustic Blend – Dark**	●		
NEW COLOR Brownstone		★	
NEW COLOR Melrose		★	
Autumn Red		●	
Mountain Cedar		●	
NEW COLOR Slate		★	
NEW COLOR Espresso		★	
Sable Brown		●	
Hearthstone		●	
Spruce		●	
Forest		●	
NEW COLOR Midnight Blue		★	
Pacific Blue		●	
NEW COLOR Wedgewood Blue		★	
Flagstone		●	
Charcoal Gray		●	
NEW COLOR Castle Stone		★	
Granite Gray		●	
Sterling Gray	●	●	
Seagrass	●	●	
Cypress		●	
Herringbone		●	
Desert Tan		●	
NEW COLOR Weathered Wood		★	
Natural Clay	●	●	
Savannah Wicker	●	●	
Light Maple		●	
Buckskin		●	
Heritage Cream		●	
Colonial White	●	●	

★ New Color
 ** Premium Colors



Siding: Cedar Impressions Triple 5" Sawmill Shingles in Sterling Gray.
Trim: Vinyl Carpentry® & Restoration Millwork®.
Porch: Colonial Post with Kingston vinyl railing with traditional balusters in White.

Cedar Impressions®

Perfection Shingles



- 7
- 36
- up to 200_{mph}
- Reinforced Nail Slots
- 3/4" Panel Projection
- Perfection
- Molded Perimeter Lock
- CertiLock Continuous Hanger
- Lifetime Limited Warranty
- Fastener Indicators
- Low Maintenance
- Drainability



Siding: Cedar Impressions Double 7" Straight Edge Perfection Shingles in Seagrass.
Trim: Vinyl Carpentry® & Restoration Millwork®.
Roof: Highland Slate in Fieldstone.



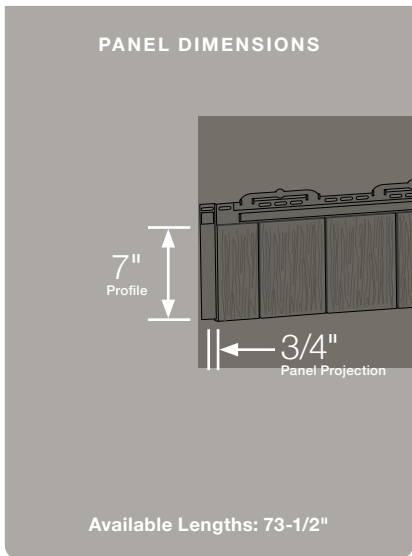
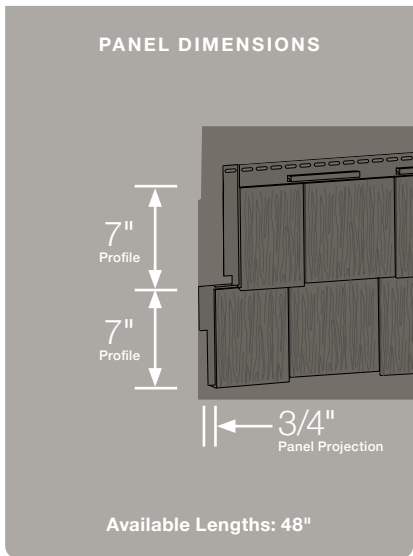
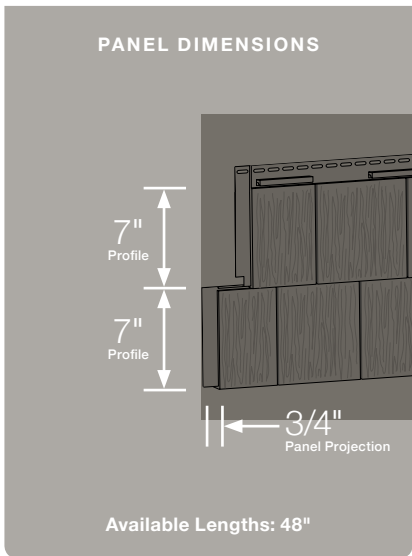



Single 6-1/3"
Perfection Scallop

Charcoal Gray



Single 6-1/3"
Perfection Octagon

Autumn Red



Single 6-1/3"
Perfection Half-Cove

Natural Clay

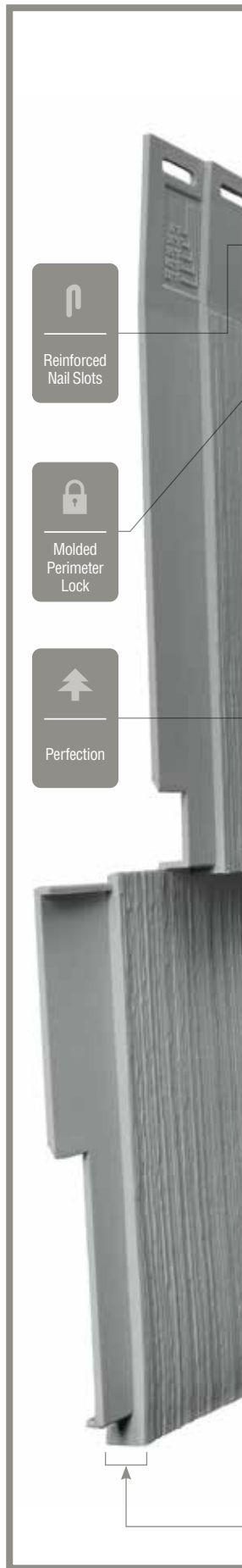
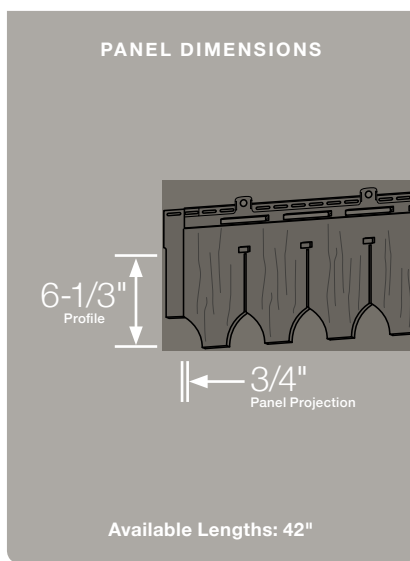
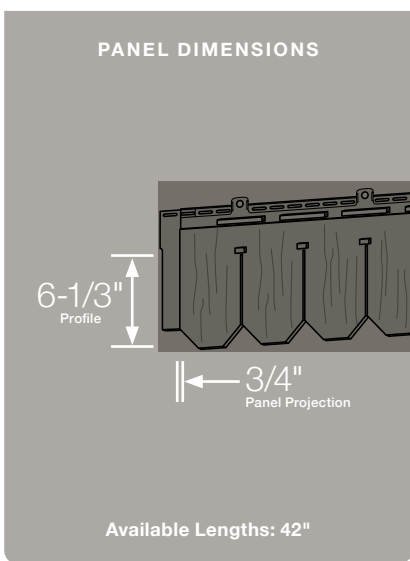
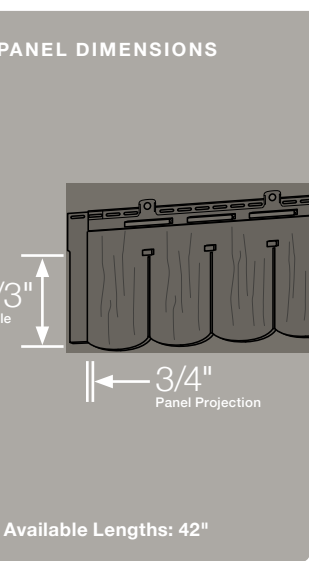



▲ Consistent variegated color throughout the panel.	D7 Straight Edge Perfection Shingles	D7 Staggered Perfection Shingles	S7 Straight Edge Perfection Shingles	S6 ^{1/3} Perfection Scallops	S6 ^{1/3} Perfection Octagon	S6 ^{1/3} Perfection Half Cove
Natural Blend**			▲			
Driftwood Blend**			▲			
Cedar Blend**			▲			
Rustic Blend**			▲			
Brownstone	★					
Melrose	★					
Autumn Red	●	●		●	●	
Mountain Cedar	●	●				
Slate	★					
Espresso	★					
Sable Brown	●	●	●			
Hearthstone	●	●	●			
Spruce	●	●				
Forest	●	●				
Midnight Blue	★					
Pacific Blue	●	●	●	●	●	●
Wedgewood Blue	★					
Flagstone	●	●	●			
Charcoal Gray	●	●	●	●	●	
Castle Stone	★					
Granite Gray	●	●	●			
Sterling Gray	●	●	●	●	●	●
Bermuda Blue	●					
Seagrass	●	●	●			
Cypress	●	●	●	●		
Herringbone	●	●				
Desert Tan	●	●				
Weathered Wood	★					
Natural Clay	●	●	●	●	●	●
Savannah Wicker	●	●	●	●		
Light Maple	●	●				
Buckskin	●	●				
Heritage Cream	●	●				
Autumn Yellow	●					
Snow	●					
Colonial White	●	●	●	●	●	●

★ New Color
 ** Premium Colors

Mitered Cornerposts for Style

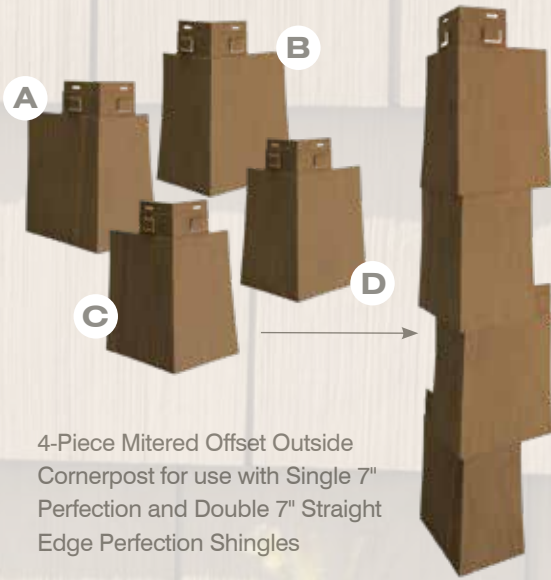

4-Piece Mitered Offset Outside
Cornerpost for use with Single 7"
Perfection and Double 7" Straight
Edge Perfection Shingles

Cedar Impressions®

Rough-Split Shakes



2



15



up to
155_{mph}



Reinforced
Nail Slots



1"
Panel
Projection



Rough-Split



Molded
Perimeter
Lock



Lifetime
Limited
Warranty



Fastener
Indicators



Low
Maintenance



Drainability



Siding: Cedar Impressions Double 9" Staggered Rough-Split Shakes in Hearsthstone.
Trim: Vinyl Carpentry® & Restoration Millwork®.





Double 7"
Straight Edge
Rough-Split Shakes



Sable Brown

Double 9"
Staggered Rough-Split Shakes

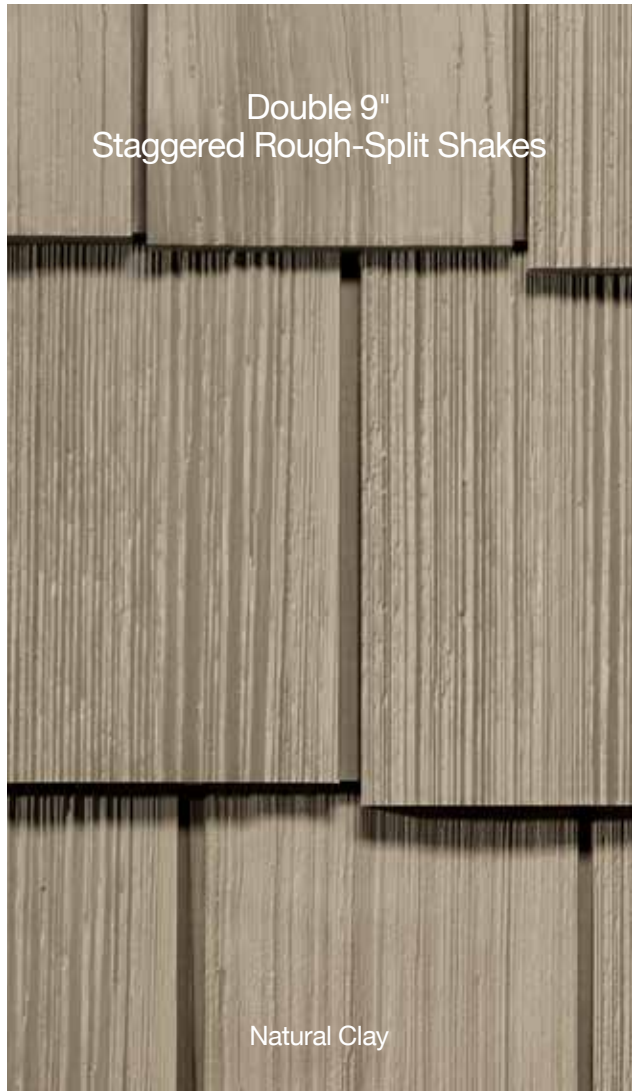

Natural Clay

PANEL DIMENSIONS

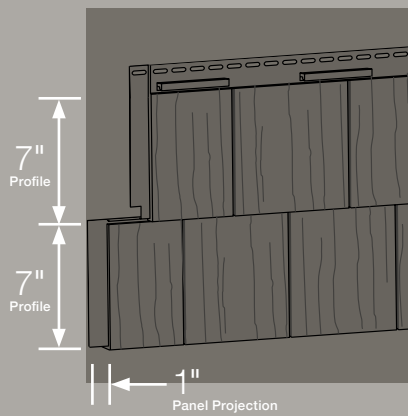

Available Lengths: 57"

PANEL DIMENSIONS

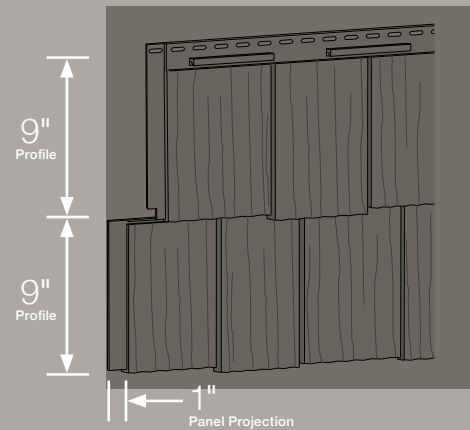

Available Lengths: 57"



	D7 Straight Edge Rough-Split Shakes	D9 Staggered Rough-Split Shakes	
Autumn Red	●	●	
Mountain Cedar	●	●	
Sable Brown	●	●	
Hearthstone	●	●	
Spruce	●	●	
Forest	●	●	
Pacific Blue	●	●	
Flagstone	●	●	
Charcoal Gray	●	●	
Granite Gray	●	●	
Sterling Gray	●	●	
Natural Clay	●	●	
Savannah Wicker	●	●	
Buckskin	●	●	
Colonial White	●	●	

Mitered Outside Corner Posts













D7" Rough-Split



D9" Rough-Split

Northwoods®

Perfection Shingles & Rough-Split Shakes

										
3	20	up to 180mph	Standard Nail Hem	3/4" Panel Projection Perfection	1" Panel Projection Rough-Split	Perfection & Rough-Split	Lifetime Limited Warranty	Class A Flame Spread	Low Maintenance	Drainability



Siding: Northwoods Single 7" Straight Edge Rough-Split Shakes in Sterling Gray and Pacific Blue and Monogram Double 4" Clapboard in Sterling Gray.
Trim: Vinyl Carpentry® & Restoration Millwork®.
Roof: Landmark® Series in Colonial Slate.





Single 7"
Straight Edge Perfection
Shingles

Granite Gray



Single 7"
Straight Edge Rough-Split
Shakes

Cypress



Single 9"
Staggered Rough-Split
Shakes

Natural Clay

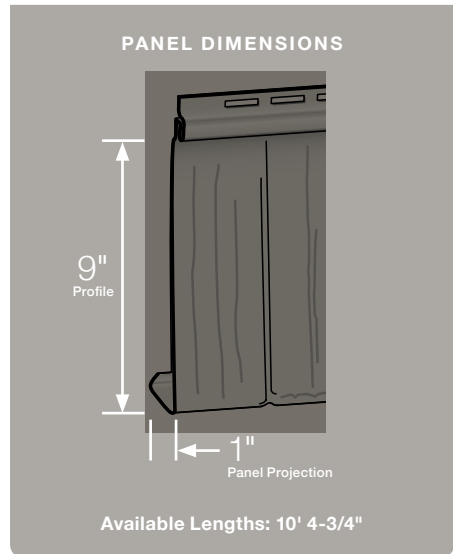
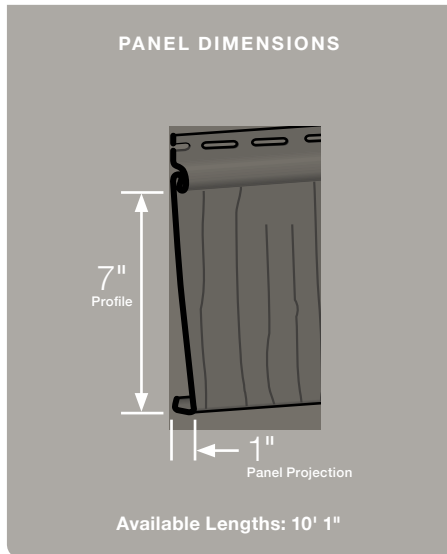
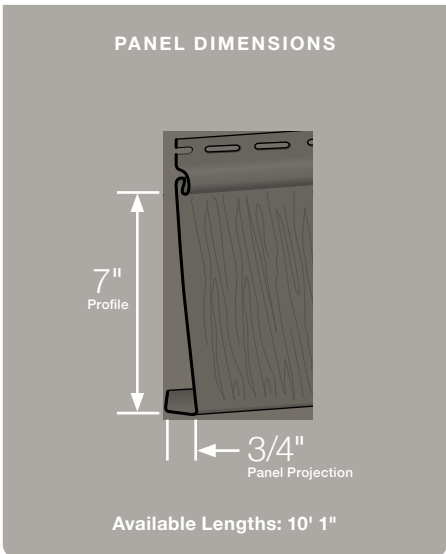



	S7 Straight Edge Perfection Shingles	S7 Straight Edge Rough-Split Shakes	S9 Staggered Rough-Split Shakes	
Autumn Red	●	●	●	
Slate	●			
Espresso	●			
Sable Brown	●	●	●	
Hearthstone	●			
Midnight Blue	●			
Pacific Blue	●	●	●	
Flagstone	●	●	●	
Charcoal Gray	●			
Castle Stone	●			
Granite Gray	●	●	●	
Sterling Gray	●	●	●	
Seagrass	●			
Cypress	●	●		
Sandstone Beige	●	●		
Desert Tan	●	●	●	
Natural Clay	●	●	●	
Savannah Wicker	●	●	●	
Buckskin	●	●	●	
Colonial White	●	●		



Siding: Northwoods Single 7" Straight Edge Rough-Split Shakes in Cypress with Monogram Double 4" Clapboard in Natural Clay.

Trim: Vinyl Carpentry® & Restoration Millwork®.

STONEfaçade®



1



4



Integrated
Fastening
Flange



Panelized



3/8"
Rainscreen



20-Year
Limited
Warranty



No Mortar



Low
Maintenance



Siding: STONEfaçade in Harbor Sunset and Cedar Impressions Individual 5" Sawmill Shingles in Cedar Blend with Monogram Double 4" in Autumn Yellow.

Trim: STONEfaçade Sill with Vinyl Carpentry® & Restoration Millwork®.





Adirondack Snowfall



Appalachian Twilight

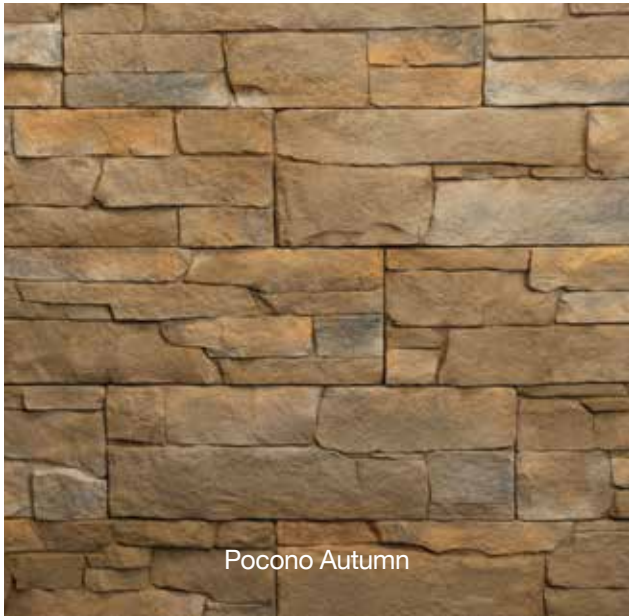

Pocono Autumn

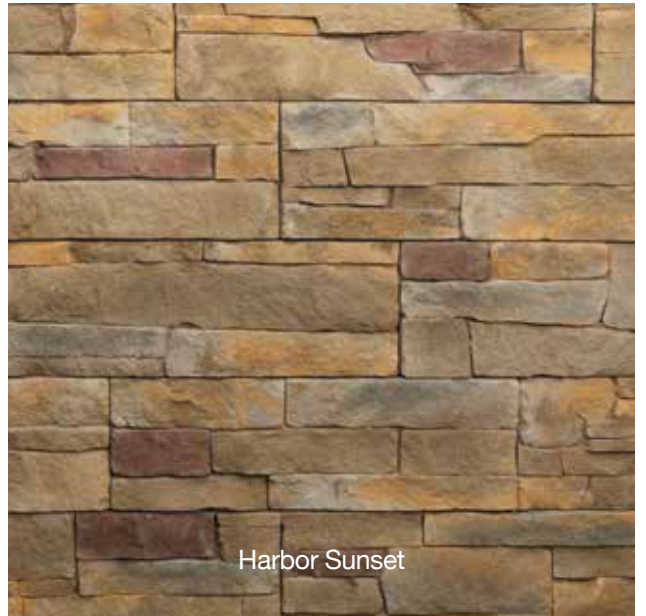

Harbor Sunset

PANEL DIMENSIONS

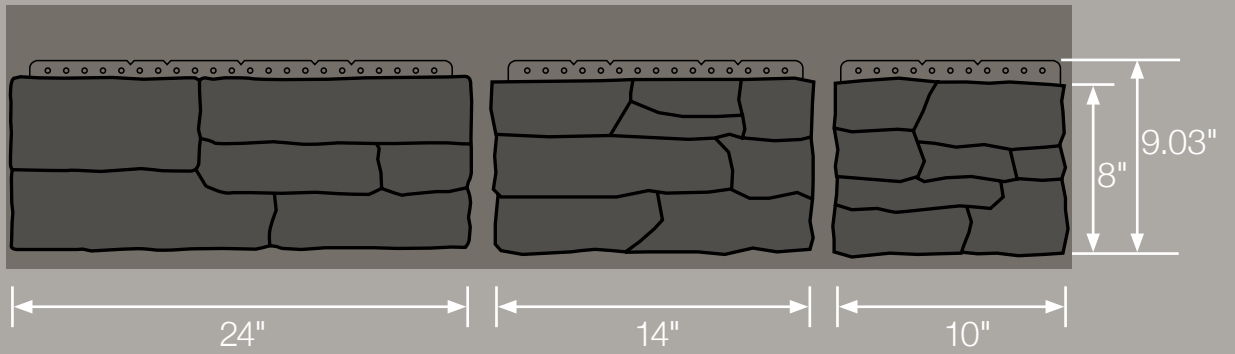

Moisture management & ease of installation

Moisture that accumulates in the wall cavity can lead to mold growth and even structural damage. The patented fully-integrated rainscreen provides STONEfaçade additional structural support and superior drainage and will prevent moisture from accumulating in the wall cavity. The rainscreen insert also incorporates a fastening flange that allows STONEfaçade to be screwed to the substrate. The mortarless install makes this product easy to install.

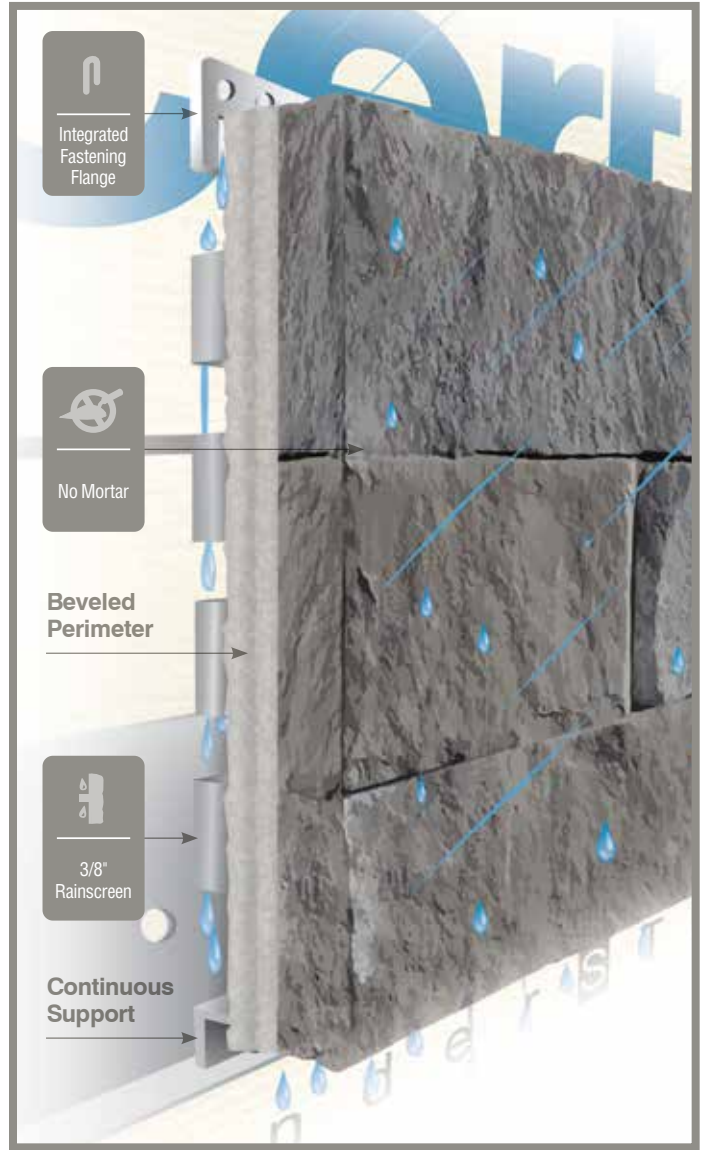

Easy-to-install stone veneer panels

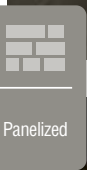

Finishing Touches

CertainTeed STONEfaçade includes a complete line of matching accessories.



Sills



Light Boxes



Electrical Boxes



Corners

CedarBoards™

Insulated Siding



.044" (D6, S7) .052" (S12)	3	up to 180mph D6, S7	20	Full Rollover Nail Hem	1-1/4" Panel Projection	TrueTexture Rough Cedar	DuraLock	Lifetime Limited Warranty	STUDfinder	Class A Flame Spread	PermaColor Fade Protection	Longer Lengths Available	Low Maintenance	Drainability



Siding: CedarBoards Single 7" Clapboard in Savannah Wicker with Cedar Impressions Double 7" Staggered Perfection in Natural Clay.
 Trim: Vinyl Carpentry® & Restoration Millwork®.
 Roof: Landmark® Promax in Weathered Wood.





Double 6"
Rough Cedar Clapboard

Flagstone



Single 7"
Rough Cedar Clapboard

Savannah Wicker



Single 12"
Rough Cedar
Board & Batten

Autumn Red

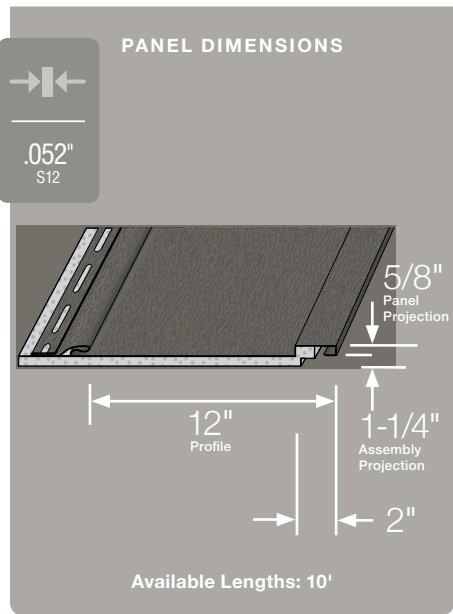
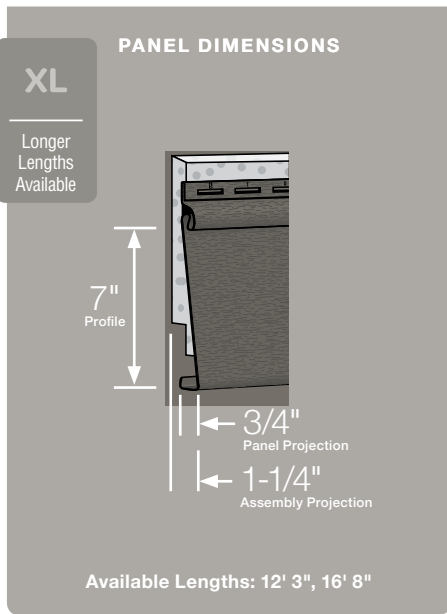
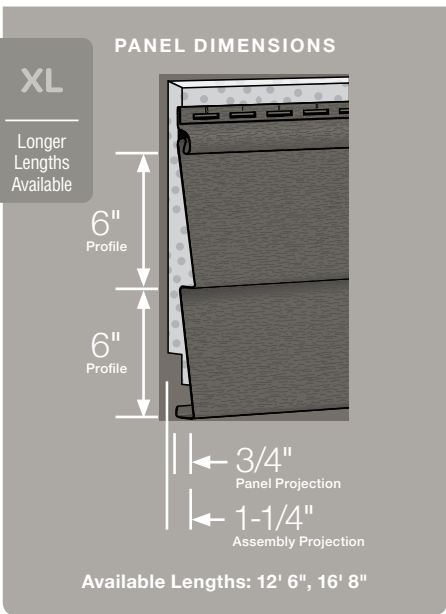



	D6 Clapboard	S7 Clapboard	S12 Clapboard	XL D6 Clapboard	XL S7 Clapboard
Autumn Red*	●	●	●	XL TEMPORARILY SUSPENDED	
Sable Brown*	●	●			
Spruce*	●	●			
Pacific Blue*	●			●	
Flagstone*	●	●		●	●
Charcoal Gray*	●	●		●	●
Granite Gray	●	●	●	●	●
Sterling Gray	●	●	●	●	●
Oxford Blue	●	●			
Cypress	●	●		●	●
NEW COLOR			★		
Herringbone					
Sandstone Beige	●	●			
Desert Tan	●	●			
Natural Clay	●	●	●	●	●
Savannah Wicker	●	●	●	●	●
Light Maple	●	●			
Buckskin	●	●			
Heritage Cream	●	●			
NEW COLOR			★		
Snow					
Colonial White	●	●	●	●	●

★ New Color
* Deluxe Colors

Finishing Touches

A full line of Vinyl Carpentry accessories specially designed for use with CedarBoards siding.



Monogram®



- .046"
- 3
- 40
- up to 210mph
- Full Rollover Nail Hem
- 3/4" Panel Projection
- TrueTexture Rough Cedar
- CertiLock
- Lifetime Limited Warranty
- STUDfinder
- Class A Flame Spread
- PermaColor Fade Protection
- Longer Lengths Available
- Low Maintenance
- Drainability



Siding: Monogram Double 4" Clapboard in Flagstone with Cedar Impressions Individual 5" Sawmill Shingles in Driftwood Blend and STONEfaçade in Adirondack Snowfall.

Trim: Vinyl Carpentry®.

Columns: Tapered Round.





Double 4"
Rough Cedar Clapboard

Brownstone



Double 5"
Rough Cedar Clapboard

Wedgewood Blue



Double 5"
Rough Cedar Dutchlap

Driftwood Blend

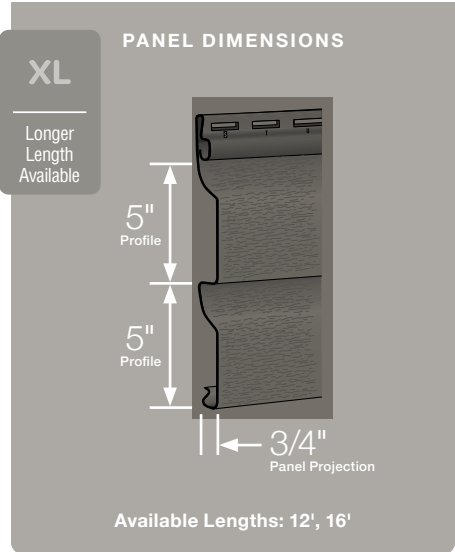
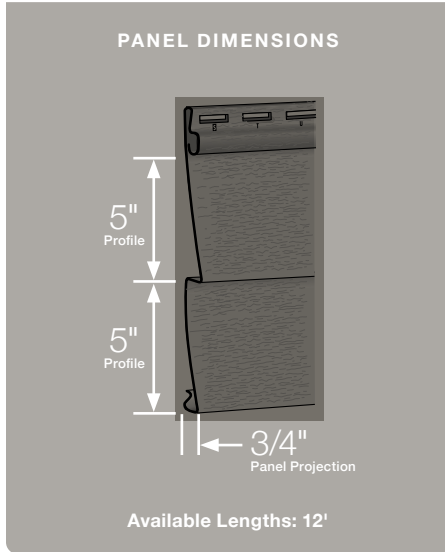
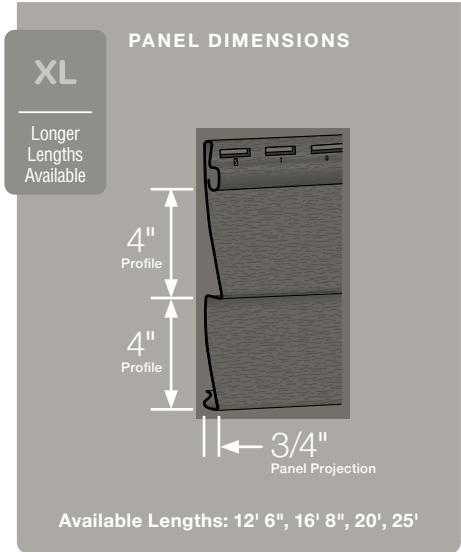

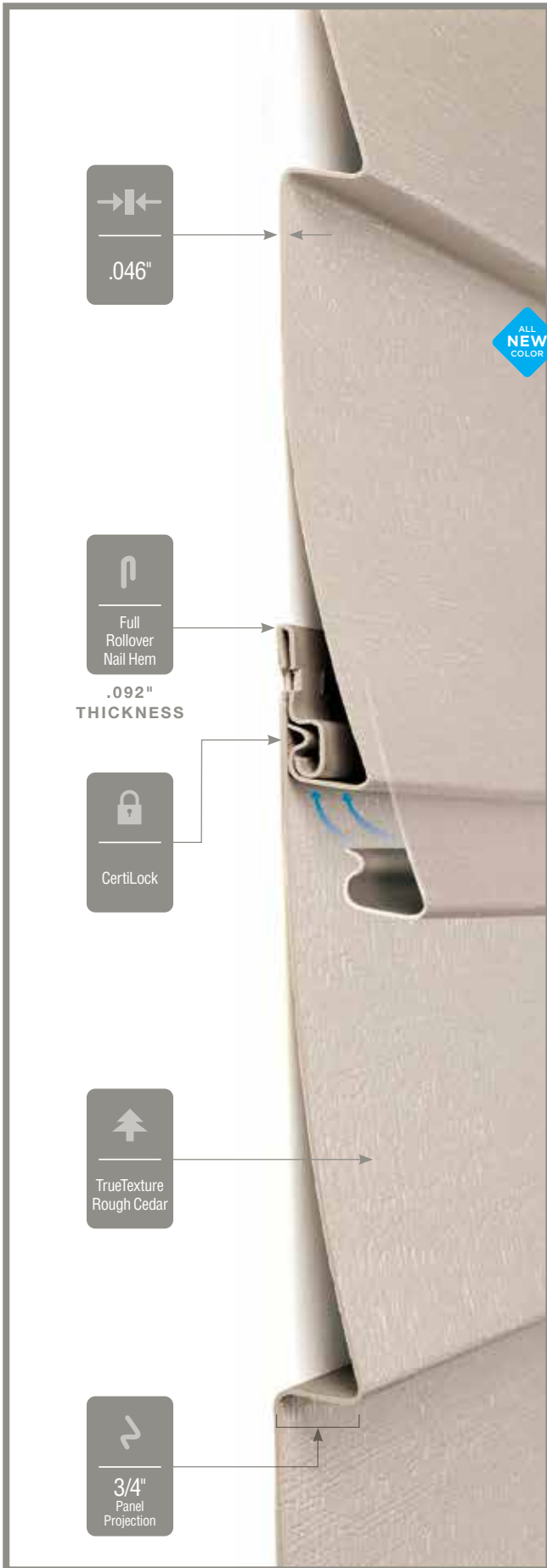

ALL NEW COLOR

COMING SOON

COMING SOON

COMING SOON

	D4 Clapboard	D5 Clapboard	D5 Dutchlap	XL Clapboard	XL Dutchlap
Arbor Blend**	●		●	20ft & 25ft LENGTHS TEMPORARILY SUSPENDED	
Weathered Blend**	●		●		
Frontier Blend**	●		●		
Natural Blend**	●		●		
Driftwood Blend**	●		●		
Cedar Blend**	●		●		
Rustic Blend**	●		●		
Brownstone*	●	●	●	●	
Melrose*	●	●	●	●	
Autumn Red*	●	●	●		
Tuxedo*	○	○	○		
Slate*	●	●	●	●	
Espresso*	●	●	●	●	
Sable Brown*	●	●	●	●	
Hearthstone*	●	●	●		
Spruce*	●	●	●		
Olive Grove*	○	○	○		
Forest*	●	●	●		
Midnight Blue*	●	●	●	●	
Pacific Blue*	●	●	●	●	
Wedgewood Blue*	●	●	●		
Flagstone*	●	●	●		
Smoky Gray	○	○	○		
Charcoal Gray*	●	●	●	●	
Castle Stone	●	●	●	●	
Granite Gray	●	●	●	●	●
Sterling Gray	●	●	●	●	●
Oxford Blue	●	●	●	●	●
Seagrass	●	●	●		
Cypress	●	●	●	●	●
Herringbone	●	●	●		
Sandstone Beige	●	●	●		
Desert Tan	●	●	●		
Weathered Wood	●	●	●		
Natural Clay	●	●	●	●	●
Savannah Wicker	●	●	●	●	●
Light Maple	●	●	●		
Buckskin	●	●	●		
Heritage Cream	●	●	●	●	●
Colonial White	●	●	●	●	●















○ Coming Soon

** Premium Colors

* Deluxe Colors

All blends have matching variegated outside corner posts available

Restoration Classic™

 .044"	 5	 30	 up to 200 _{mph}	 Full Rollover Nail Hem	 5/8" Panel Projection	 Select Cedar Woodgrain & Smooth	 DuraLock	 Lifetime Limited Warranty	 STUDfinder	 Class A Flame Spread	 PermaColor Fade Protection	 Low Maintenance	 Drainability
---	--	---	--	---	--	--	---	--	--	--	---	---	---



Siding: Restoration Classic Double 4" Clapboard in Midnight Blue with Northwoods Single 7" Straight Edge Perfection Shingles in Midnight Blue and Granite Gray and Board & Batten S7" in Granite Gray.
Trim: Vinyl Carpentry® & Restoration Millwork®.



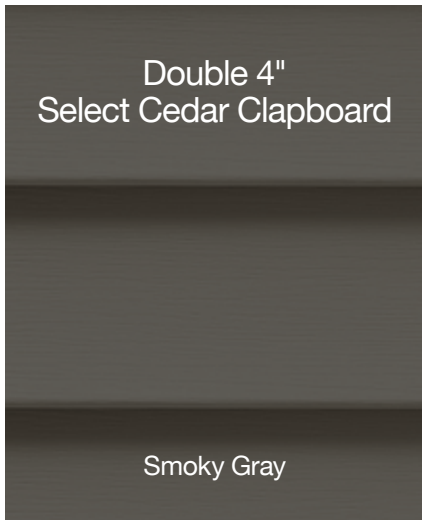

Double 4"
Select Cedar Clapboard

Smoky Gray



Double 4-1/2"
Select Cedar Dutchlap

Olive Grove



Double 5"
Select Cedar Clapboard

Heritage Cream

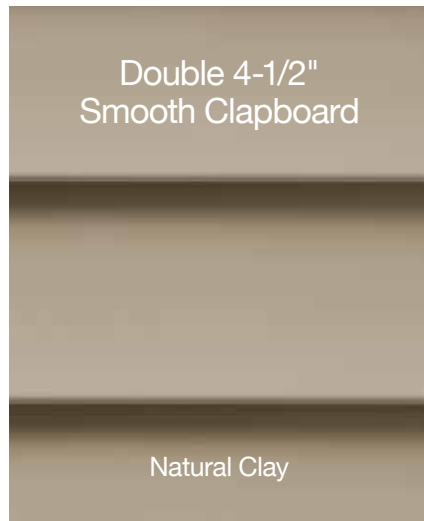
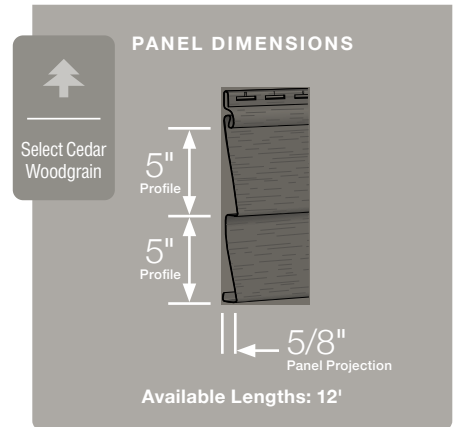
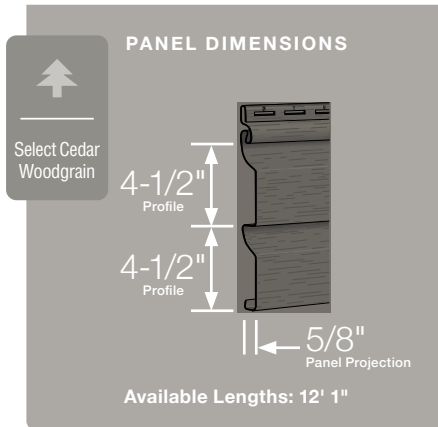
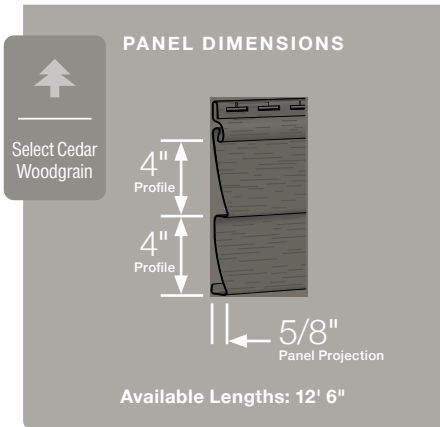

Double 4-1/2"
Smooth Clapboard

Natural Clay

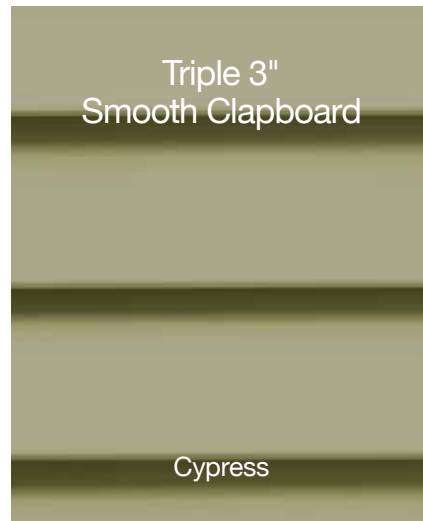

Triple 3"
Smooth Clapboard

Cypress

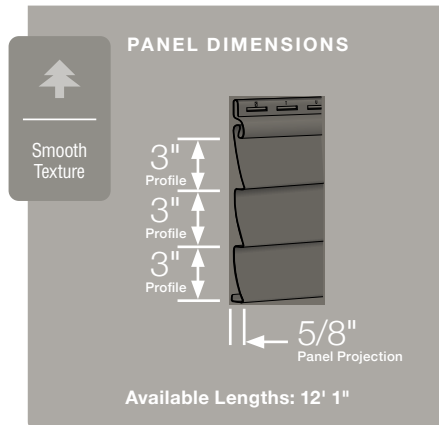
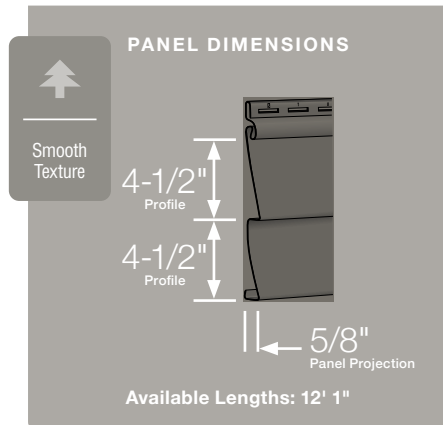

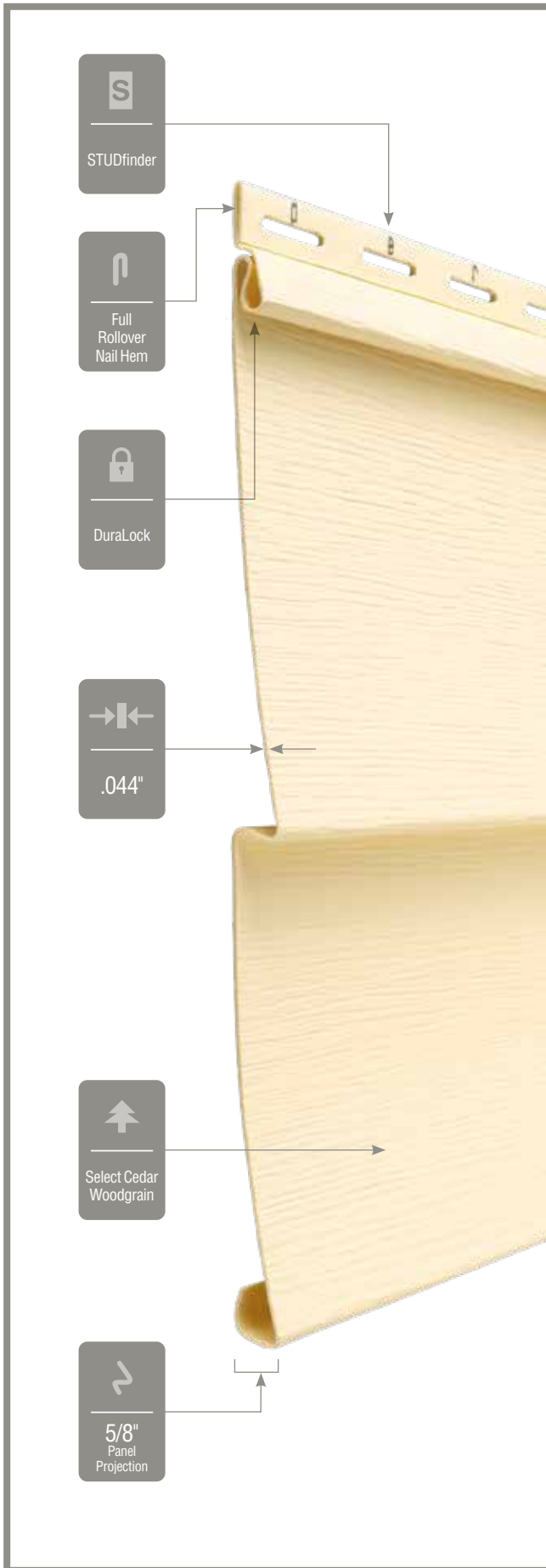

	D4 Clapboard	D4 ^{1/2} Dutchlap	D5 Clapboard	D4 ^{1/2} Clapboard	T3 Clapboard
Melrose*	●	●			
Autumn Red*	●	●			
Mountain Cedar*	●	●			
Slate*	●	●			
Espresso*	●	●			
Sable Brown*	●	●			
Hearthstone*	●	●			
Spruce*	●	●			
Olive Grove*	●	●			
Forest*	●	●			
Midnight Blue*	●	●			
Pacific Blue*	●	●			
Flagstone*	●	●			
Smoky Gray	●	●			
Charcoal Gray*	●	●			
Castle Stone	●	●			
Granite Gray	●	●	●	●	●
Sterling Gray	●	●	●	●	●
Oxford Blue	●	●	●		
Seagrass	●	●	●		
Cypress	●	●	●	●	●
Herringbone	●	●	●	●	●
Desert Tan	●	●	●		
Natural Clay	●	●	●	●	●
Savannah Wicker	●	●	●	●	●
Light Maple	●	●	●		
Buckskin	●	●			
Heritage Cream	●	●	●		
Autumn Yellow	●	●	●		
Colonial White	●	●	●	●	●

* Deluxe Colors



Siding: Restoration Classic Double 4" Clapboard in Espresso.
Trim: Vinyl Carpentry® & Restoration Millwork®.

Board & Batten

Vertical Siding



.052" S7	.048" S8	3	29	up to 165mph	Standard Nail Hem	1/2" Panel Projection	TrueTexture Rough Cedar	Lifetime Limited Warranty	Class A Flame Spread	PermaColor Fade Protection	Low Maintenance	Drainability



Siding: Board & Batten Single 8" with Cedar Impressions
 Double 7" Staggered Perfection Shingles in Cypress
 Trim: Vinyl Carpentry® & Restoration Millwork®

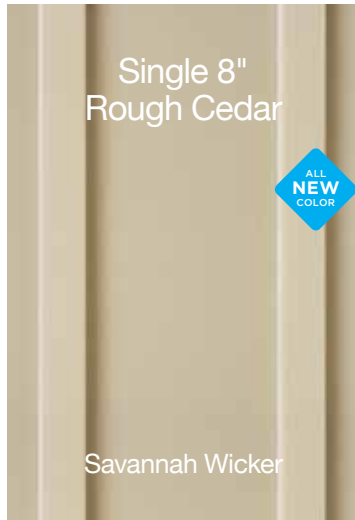
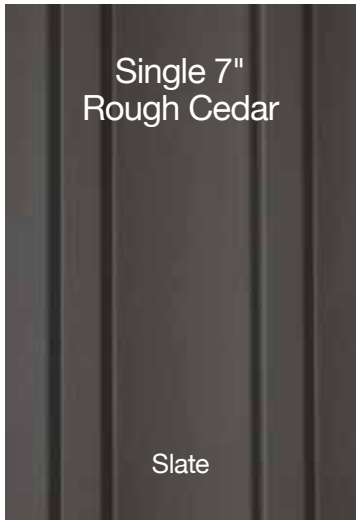

ALL
NEW
COLOR

COMING
SOON

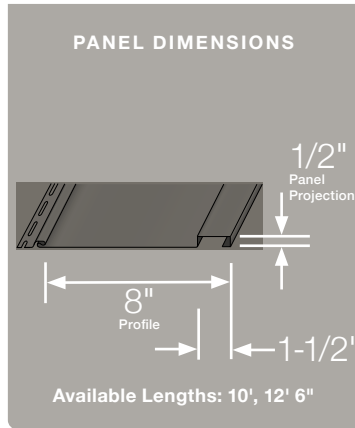
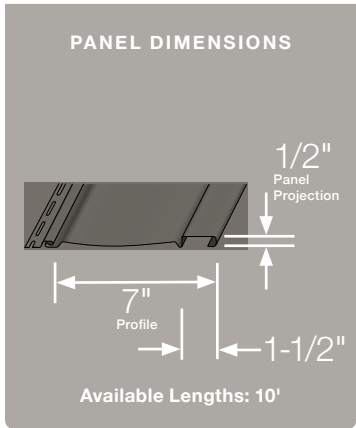

COMING
SOON

COMING
SOON

	S7 Board & Batten	S8 Board & Batten
Brownstone*	●	
Melrose*	●	
Autumn Red*	●	
Tuxedo*	○	
Slate*	●	
Espresso*	●	
Sable Brown*	●	
Hearthstone*	●	
Spruce*	●	
Forest*	●	
Midnight Blue*	●	
Pacific Blue*	●	
Wedgewood Bue	○	
Flagstone*	●	
Smoky Gray	○	
Charcoal Gray*	●	
Castle Stone	●	
Granite Gray	●	●
Sterling Gray	●	●
Cypress	●	●
Herringbone	●	●
Sandstone Beige		●
Desert Tan		●
Weathered Wood	○	
Natural Clay	●	●
Savannah Wicker	●	●
Light Maple		●
Snow		★
Colonial White	●	●

COMING
SOON

NEW
COLOR

★ New Color
○ Coming Soon
* Deluxe Colors

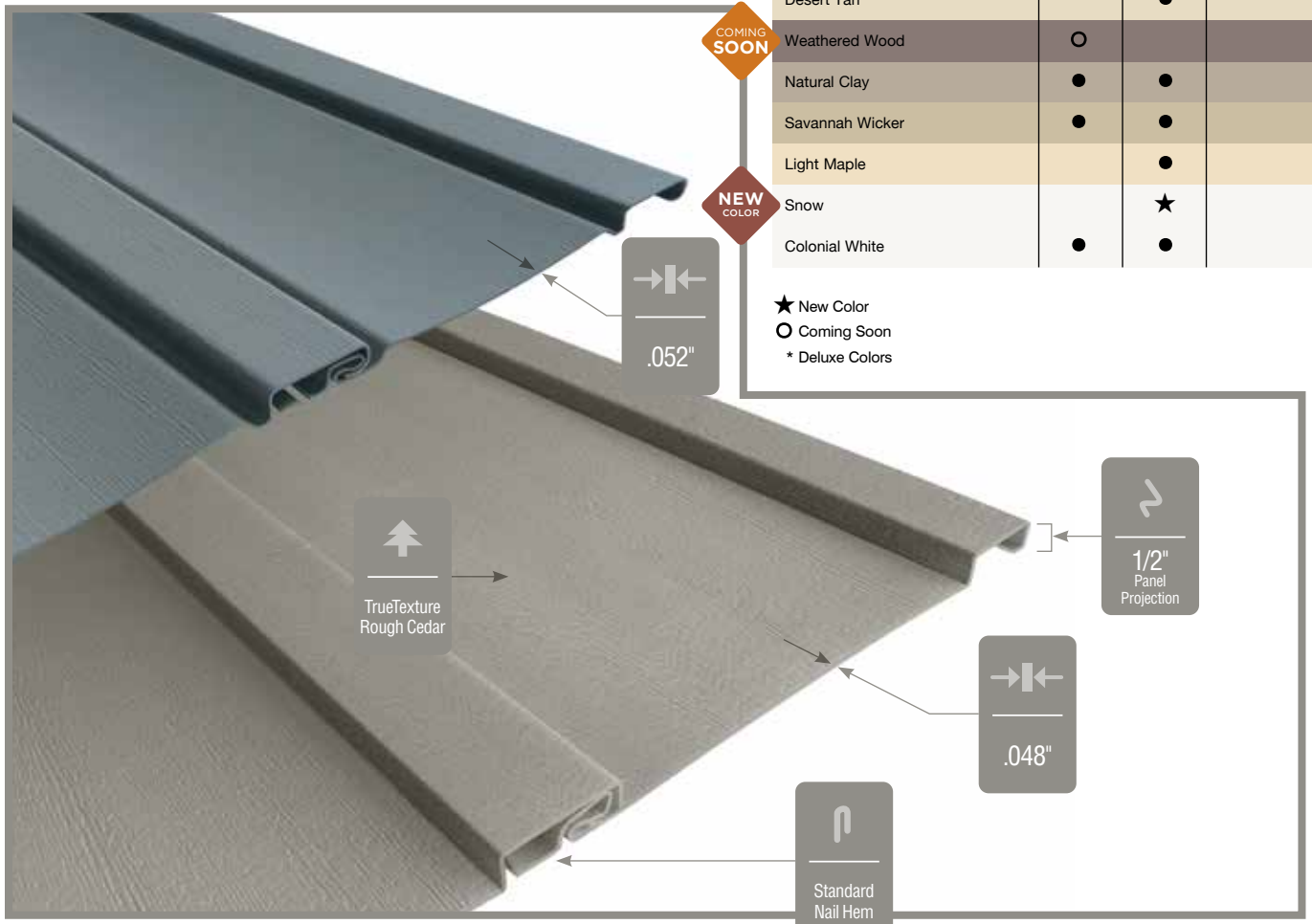

Reverse Board & Batten

Reinforced Vertical Siding

COMING
SOON



.046"



1



10



up to
150_{mph}



Partial
Rollover
Nail Hem



3/4"
Panel
Projection



Woodgrain



Lifetime
Limited
Warranty



Class A
Flame Spread



PermaColor
Fade
Protection



Low
Maintenance



Drainability



Siding: Reverse Board & Batten Single 7" Reinforced Vertical Siding and Restoration Classic Double 4-1/2" Natural Clay, Cedar Impressions Double 7" Straight Edge Perfection Shingles in herringbone with Ironmax Double 5" Vented Soffit in Colonial White.
Trim: Vinyl Carpentry® & Restoration Millwork®

Single 7" Reinforced Vertical Siding

Midnight Blue

PANEL DIMENSIONS

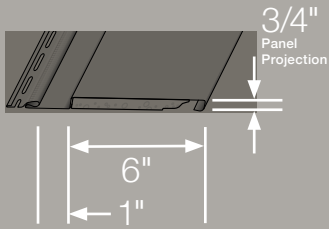

Available Length: 10'

S7
Reverse Board & Batten

Autumn Red*

○

Sable Brown*

○

Midnight Blue*

○

Pacific Blue*

○

Charcoal Gray*

○

Granite Gray

○

Sterling Gray

○

Natural Clay

○

Savannah Wicker

○

Colonial White

○

○ Coming Soon



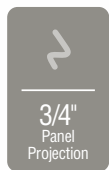



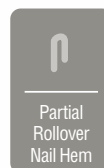







* Deluxe Colors



Reinforcing foam



Carolina Beaded™

 .044"	 1	 15	 up to 130 _{mph}	 Standard Nail Hem	 3/4" Panel Projection	 Brushed	 Post-formed	 Lifetime Limited Warranty	 STUDfinder	 Class A Flame Spread	 PermaColor Fade Protection	 Low Maintenance	 Drainability
---	--	---	--	---	--	--	--	--	--	--	---	---	---



Siding: Carolina Beaded Single 6-1/2" in Heritage Cream.
Trim: Vinyl Carpentry® & Restoration Millwork®.

Single 6-1/2"
Brushed Beaded



Granite Gray

PANEL DIMENSIONS

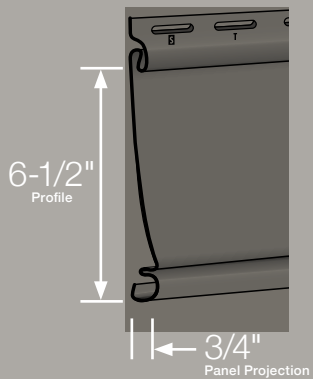

Available Lengths: 12' 4"

S6^{1/2}
Beaded

Castle Stone



Granite Gray



Sterling Gray



Oxford Blue



Seagrass



Cypress



Herringbone



Sandstone Beige



Desert Tan



Natural Clay



Savannah Wicker



Light Maple



Heritage Cream

















Snow



Colonial White



MainStreet™

-  .042"
-  7
-  25
-  up to 170_{mph}
-  Partial Rollover Nail Hem
-  9/16" Panel Projection
-  Woodgrain & Brushed
-  DuraLock
-  Lifetime Limited Warranty
-  STUDfinder
-  Class A Flame Spread
-  PermaColor Fade Protection
-  Low Maintenance
-  Drainability



Siding: MainStreet Single 8" Clapboard in Colonial White.
Trim: Vinyl Carpentry® & Restoration Millwork®.





Triple 3"
Brushed
Clapboard

Light Maple



Double 4"
Woodgrain
Clapboard

Natural Clay



Double 5"
Woodgrain
Clapboard

Herringbone

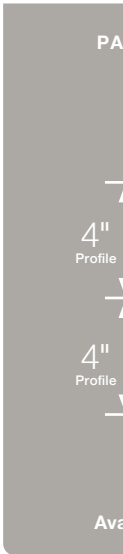
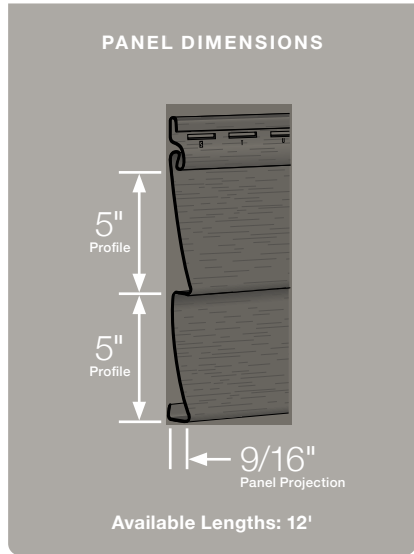
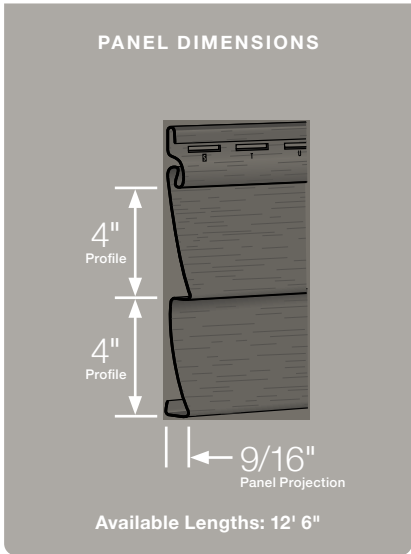
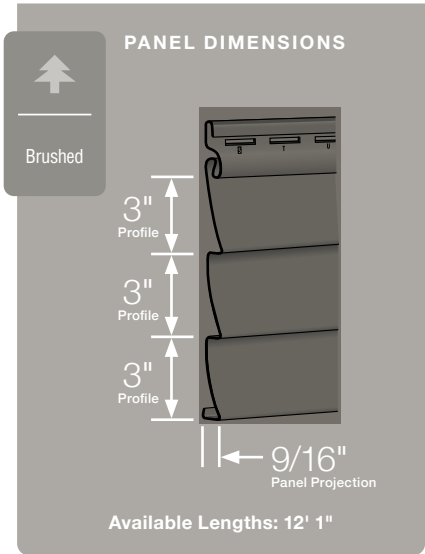

Double 4"
Woodgrain
Dutchlap

Granite Gray

Double 5"
Woodgrain
Dutchlap

Forest

Single 6-1/2"
Brushed Beaded

Cypress

Single 8"
Woodgrain
Clapboard

Colonial White

PANEL DIMENSIONS

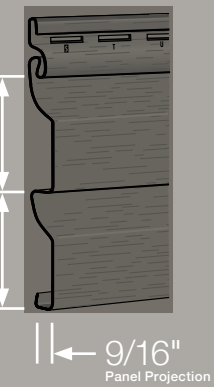

Available Lengths: 12' 6"

PANEL DIMENSIONS

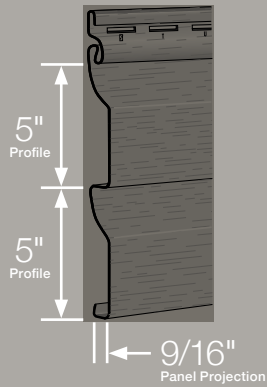

Available Lengths: 12'

PANEL DIMENSIONS

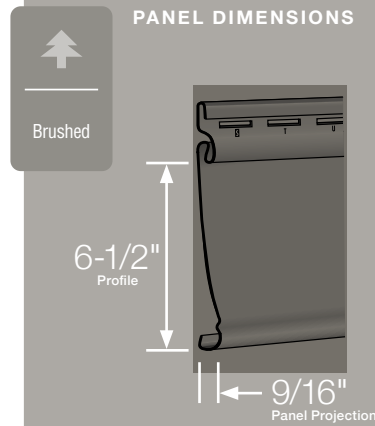

Available Lengths: 12' 4"

PANEL DIMENSIONS

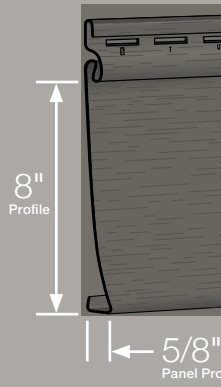

Available Lengths: 12' 6"

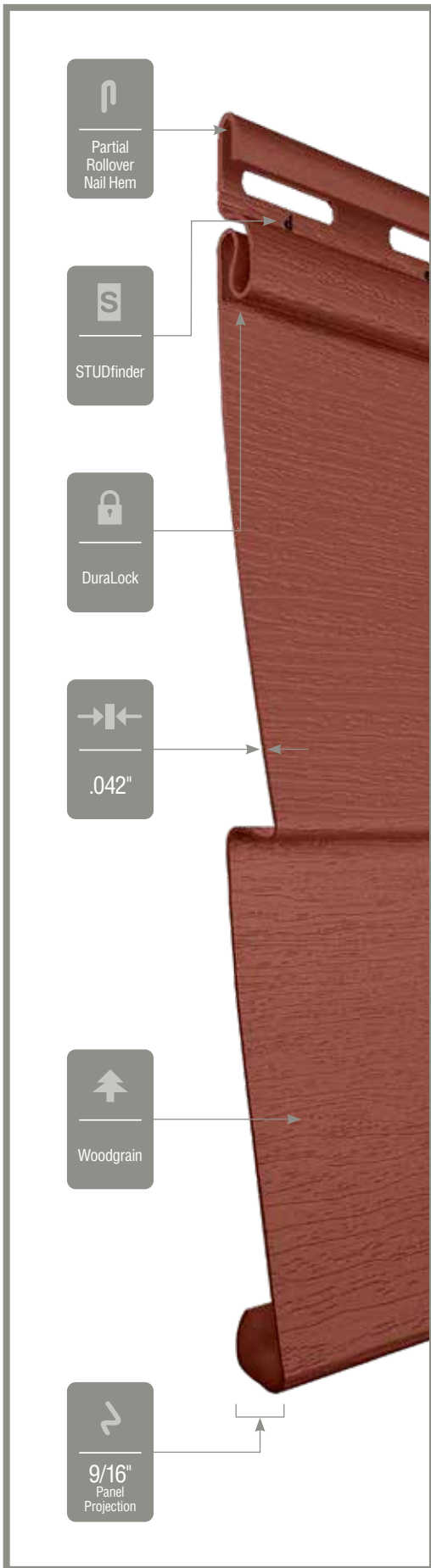

	T3 Clapboard	D4 Clapboard	D5 Clapboard	D4 Dutchlap	D5 Dutchlap	S6 ^{1/2} Beaded	S8 Clapboard
Autumn Red*		●	●	●	●		
Sable Brown*		●	●	●	●		
Hearthstone*		●	●	●	●		
Spruce*		●	●	●	●		
Forest*		●	●	●	●		
Pacific Blue*		●	●	●	●		
Flagstone*		●	●	●	●		
Charcoal Gray*		●	●	●	●		
Castle Stone		●	●	●	●		
Granite Gray		●	●	●	●	●	
Sterling Gray	●	●	●	●	●	●	
Oxford Blue	●	●	●	●	●		
Seagrass		●	●	●	●		
Cypress		●	●	●	●	●	
Herringbone		●	●	●	●		
Sandstone Beige	●	●	●	●	●	●	
Desert Tan	●	●	●	●	●	●	
Natural Clay	●	●	●	●	●	●	
Savannah Wicker	●	●	●	●	●	●	
Light Maple	●	●	●	●	●		
Buckskin		●	●	●	●		
Heritage Cream		●	●	●	●		
Autumn Yellow		●	●	●	●		
Snow	●	●	●	●	●		
Colonial White	●	●	●	●	●	●	●

* Deluxe Colors



Siding: MainStreet Double 4" Clapboard in Cypress.
 Accents: Cedar Impressions Half-Round Shingles in Colonial White and Natural Clay.
 Trim: Vinyl Carpentry® & Restoration Millwork®.



Siding: MainStreet Double 4" Clapboard in Flagstone.
Trim: Vinyl Carpentry® & Restoration Millwork®.

Wolverine American Legend™



.042"



3



21



up to
140_{mph}



Standard
Nail Hem



9/16"
Panel
Projection



Woodgrain



GripLock



Lifetime
Limited
Warranty



STUDfinder



Class A
Flame Spread



PermaColor
Fade
Protection



Low
Maintenance



Drainability



Siding: Wolverine American Legend Double 4" Clapboard in Buckskin.
Trim: Vinyl Carpentry® & Restoration Millwork®.

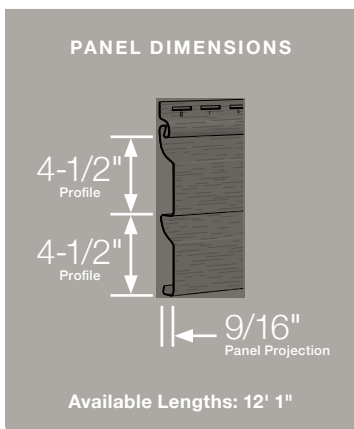
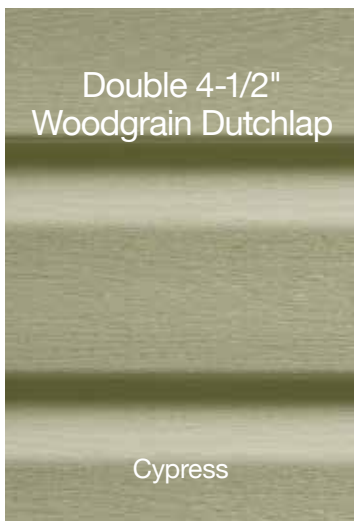
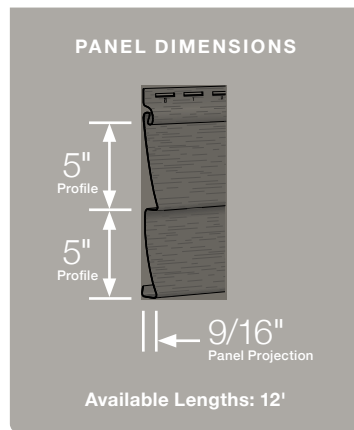
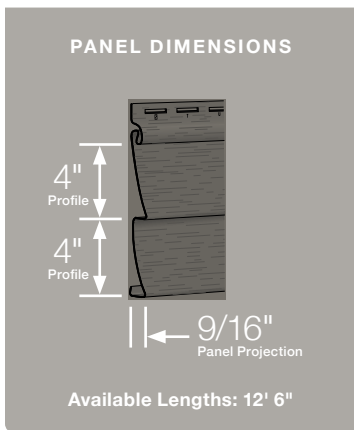
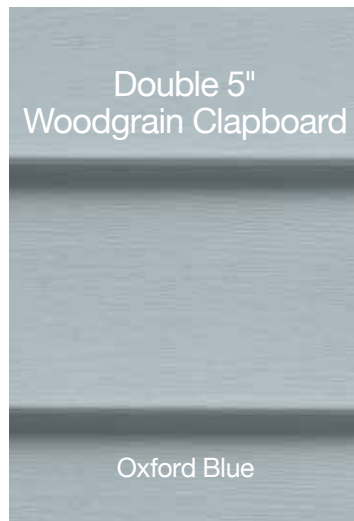
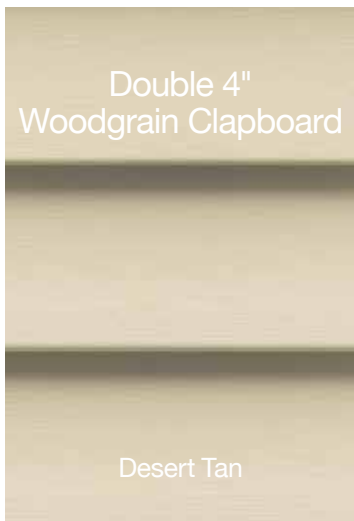





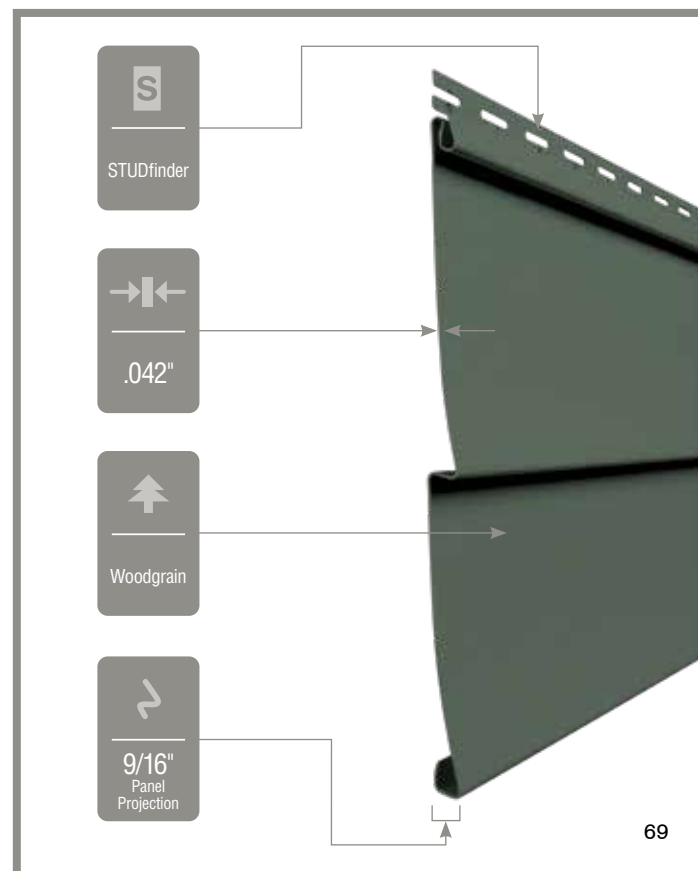









	D4 Clapboard	D5 Clapboard	D4 ^{1/2} Dutchlap	
Autumn Red*	●	●	●	
Hearthstone*	●	●	●	
Spruce*	●	●	●	
Forest*	●	●	●	
Flagstone*	●	●	●	
Charcoal Gray*	●	●	●	
Granite Gray	●	●	●	
Sterling Gray	●	●	●	
Oxford Blue	●	●	●	
Seagrass	●	●	●	
Cypress	●	●	●	
Herringbone	●	●	●	
Desert Tan	●	●	●	
Natural Clay	●	●	●	
Savannah Wicker	●	●	●	
Light Maple	●	●	●	
Buckskin	●	●	●	
Heritage Cream	●	●	●	
Autumn Yellow	●	●	●	
Snow	●	●	●	
Colonial White	●	●	●	

* Deluxe Colors



Encore™

-  .040"
-  3
-  15
-  up to 170_{mph}
-  Partial Rollover Nail Hem
-  1/2" Panel Projection
-  Woodgrain
-  Post-formed
-  Lifetime Limited Warranty
-  STUDfinder
-  Class A Flame Spread
-  PermaColor Fade Protection
-  Low Maintenance
-  Drainability



Siding: Encore Double 4" Clapboard in Castle Stone.
Trim: Vinyl Carpentry® & Restoration Millwork®.

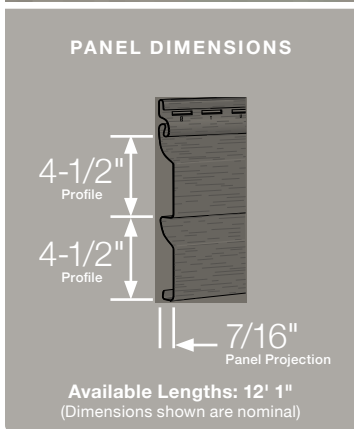
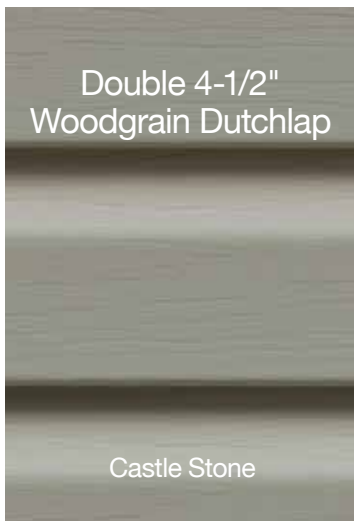
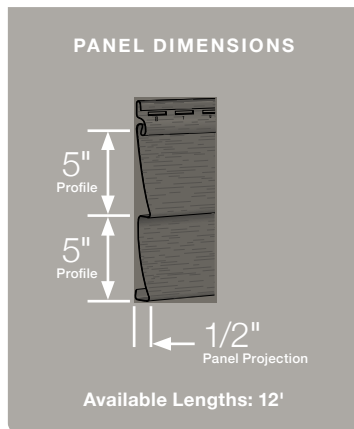
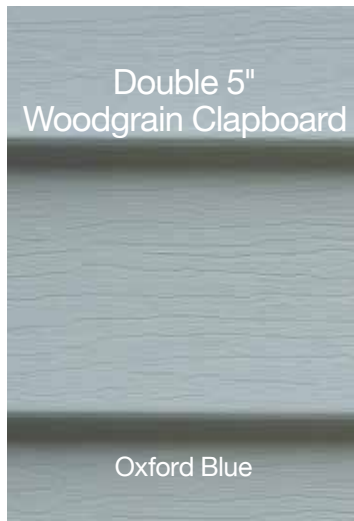
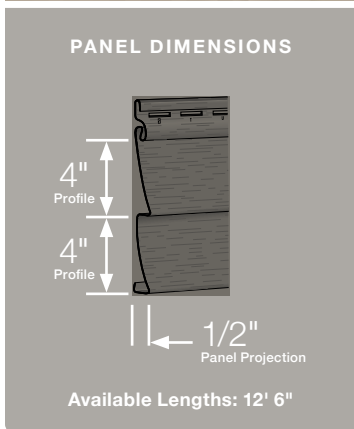
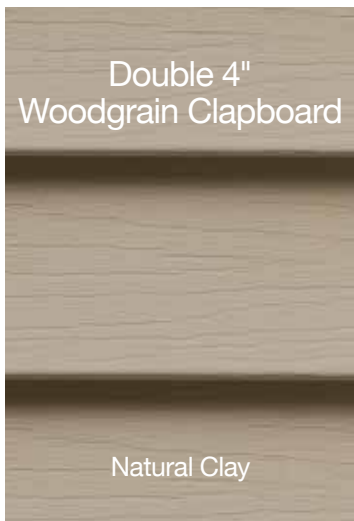

	D4 Clapboard	D5 Clapboard	D4 ^{1/2} Dutchlap	
Castle Stone	●	●	●	
Sterling Gray	●	●	●	
Oxford Blue	●	●	●	
Seagrass	●	●	●	
Cypress	●	●	●	
Natural Clay	●	●	●	
Herringbone	●	●	●	
Sandstone Beige	●	●	●	
Desert Tan	●	●	●	
Savannah Wicker	●	●	●	
Light Maple	●	●	●	
Buckskin	●	●	●	
Heritage Cream	●	●	●	
Snow	●	●	●	
Colonial White	●	●	●	

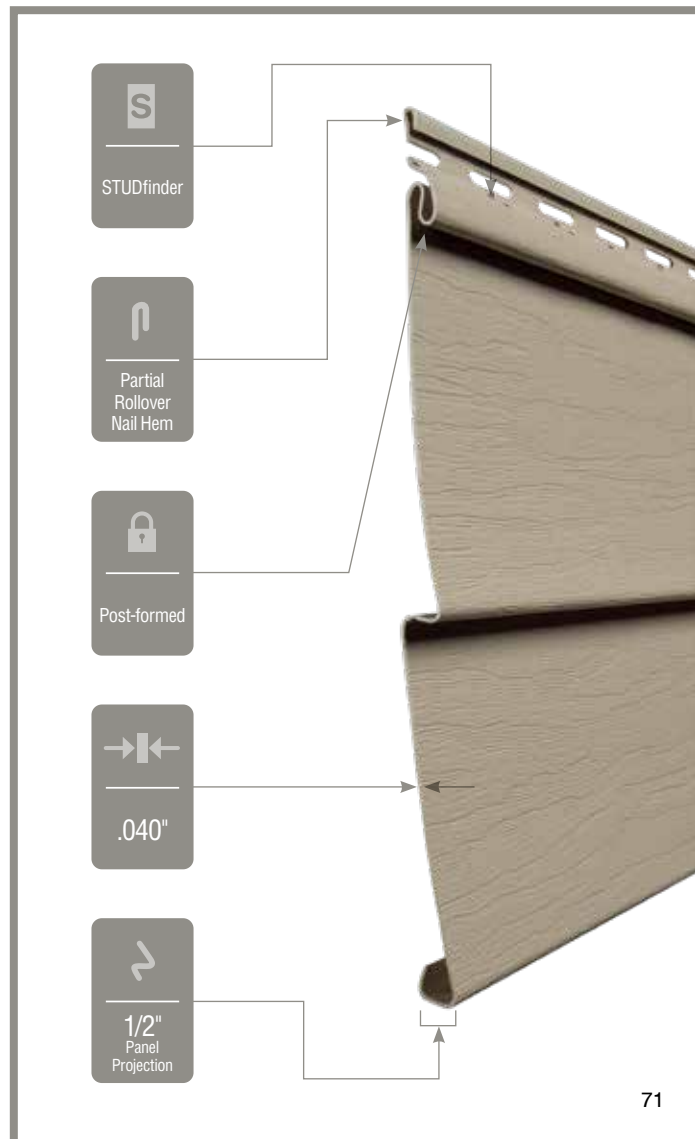

Triple 3-1/3" Soffit & Vertical Siding

- InvisiVent® and solid styles.
- The only vinyl soffit to provide up to 10 inches of net-free intake area per square foot.
- Concealed intake vents provide a smooth appearance.
- Matte finish looks like freshly painted wood.
- Deep 3/4" panel projection creates sharp definition.
- 7 low-gloss colors.
- Heavy-duty .044" thickness for rigidity.

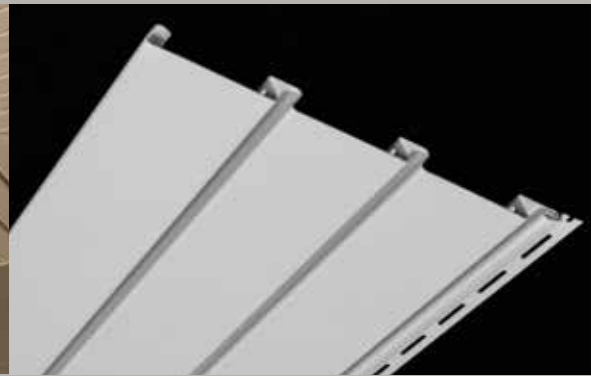

Perimeter™ Triple 3-1/3" Soffit & Vertical Siding

- Solid and hidden vent styles.
- 10 low-gloss colors.
- .040" thickness.
- Hidden vent style provides up to 9.65 inches of net-free intake area per square foot.

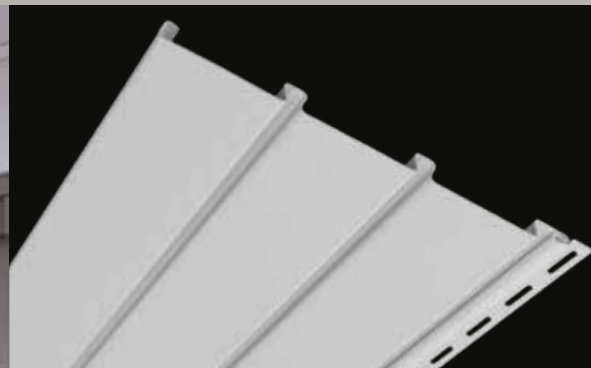

Beaded Triple 2" Soffit & Vertical Siding

- Wainscot style in solid and invisibly vented.
- Designed for vertical siding, porch ceiling and soffit applications.
- Smooth finish of professionally applied paint.
- Extra-long slip-lock design helps provide secure installation.
- 7 low-gloss colors.
- .039" thickness.
- 1.6 inches of net-free air per square feet – invisibly vented.





Triple 3-1/3" InvisiVent

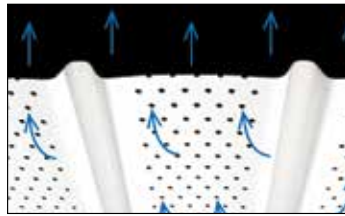

Standard vented soffit

Hidden vents provide a smooth, flat non-perforated surface versus most vented soffits with unsightly perforations.

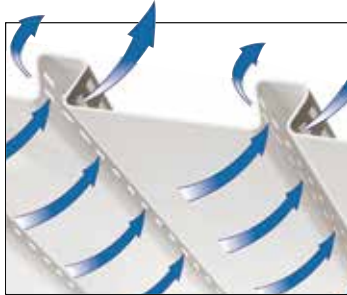

Triple 3-1/3" InvisiVent offers at least 50% more ventilation than most standard vinyl soffit, providing more than 10" of net-free intake area. This means that not only will InvisiVent provide a balanced ventilation system, but will do so with an overhang as short as 10".

COMING SOON

NEW COLOR

T3^{1/3}
Solid and InvisiVent

T3^{1/3}
Perimeter

T2
Beaded

Black** soffit use only

	T3 ^{1/3} Solid and InvisiVent	T3 ^{1/3} Perimeter	T2 Beaded
Charcoal Gray		●	
Granite Gray	●	●	
Sterling Gray			●
Herringbone		★	
Sandstone Beige	●	●	●
Desert Tan	●	●	●
Natural Clay	●	●	●
Savannah Wicker	●	●	●
Snow	●	●	●
Colonial White	●	●	●

★ New Color
○ Coming Soon
** Premium Colors

Proper Ventilation is Critical

Protection against damage to the roofing materials and structure increase comfort inside the home and energy savings.

Soffit Vents (intake)

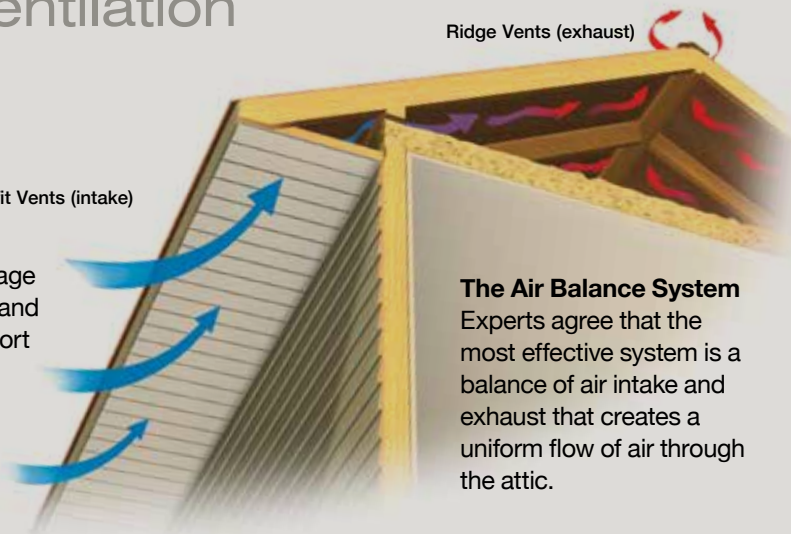

Ridge Vents (exhaust)

The Air Balance System
Experts agree that the most effective system is a balance of air intake and exhaust that creates a uniform flow of air through the attic.

This system creates a condition in which the roof temperature is equalized from top to bottom, supplying a uniform air flow along the entire underside of the roof deck.



Beaded Triple 2" in Colonial White.



Triple 3-1/3" InvisiVent in Colonial White.

Ironmax™ Double 5" Soffit & Vertical Siding

- Solid and fully vented styles.
- Extra-thick .046" construction for optimum strength and flat face appearance.
- Designed for vertical siding, porch ceiling and soffit applications.
- Unique post-formed lock design helps ensure secure installation.
- 10 low-gloss woodgrain colors (sable brown for soffit applications only).
- 6.4 inches of net-free air per sq. ft. - fully vented.



Universal Triple 4" Soffit & Vertical Siding

- Solid, fully vented and center vented styles. (Dimensions shown are nominal).
- Designed for vertical siding, porch ceiling and soffit applications.
- Matte finish.
- Post-formed lock design helps provide secure installation.
- 30 low-gloss colors (center vented: colonial white and snow only).
- .040" thickness.
- 5.9" of net-free air per sq.ft. - fully vented.
- 2 inches of net-free air per sq. ft. - center vented.

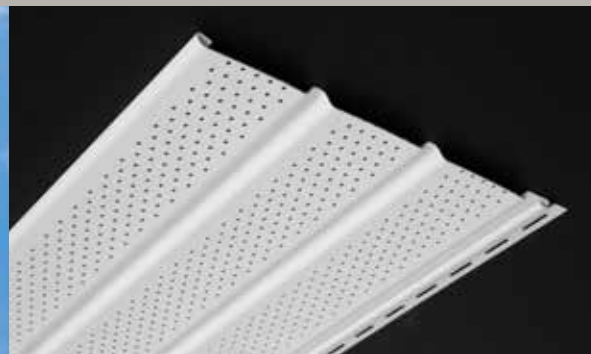

Universal Double 5" Soffit

- Solid and fully vented styles (soffit use only).
- Designed for soffit applications.
- Woodgrain finish.
- 9 low-gloss colors
- .040" thickness.
- RigidForm technology provides strengthened nail hem for rigidity to perform under high wind conditions.
- 6.4 inches of net-free air per sq.ft. - fully vented.

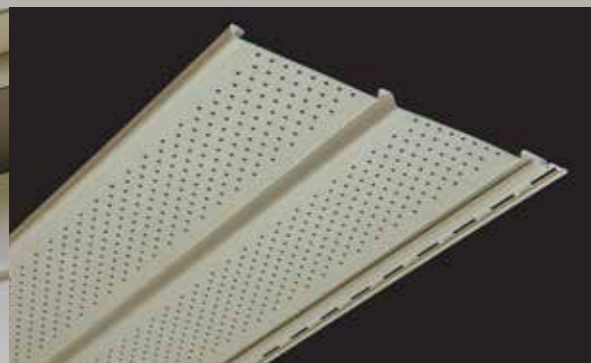

Value Triple 4" & Double 5" Soffit

- Solid, fully vented and center vented styles.
- For use in new construction and remodeling.
- Post-formed lock design helps provide secure installation.
- Triple 4: 6 low-gloss colors (center vented: colonial white only). (Dimensions shown are nominal).
- Double 5: 1 low-gloss color.



Ironmax Double 5" in Colonial White.

COMING SOON

	D5 Ironmax	T4 Universal	D5 Universal	T4 Value	D5 Value
Black** <i>soffit use only</i>		○			
Musket Brown** <i>soffit use only</i>		●	●		
Brownstone		●			
Melrose		●			
Autumn Red		●			
Slate		●			
Espresso		●			
Sable Brown	●	●			
Hearthstone		●			
Forest		●			
Midnight Blue		●			
Pacific Blue		●			
Flagstone		●			
Charcoal Gray		●			
Castle Stone		●			
Granite Gray	●	●			
Sterling Gray	●	●	●		
Oxford Blue		●			
Cypress		●			
Herringbone		●	●		
Sandstone Beige	●	●	●	●	
Desert Tan	●	●	●	●	
Natural Clay	●	●	●	●	
Savannah Wicker	●	●	●	●	
Light Maple	●	●	●	●	
Buckskin		●			
Heritage Cream		●			
Snow	●	●		●	
Colonial White	●	●	●	●	●

★ New Color
 ○ Coming Soon
 ** Premium Colors

Vinyl Carpentry®

Decorative Trim



T5" Straight Edge Sawmill
Offset Mitered Cornerpost

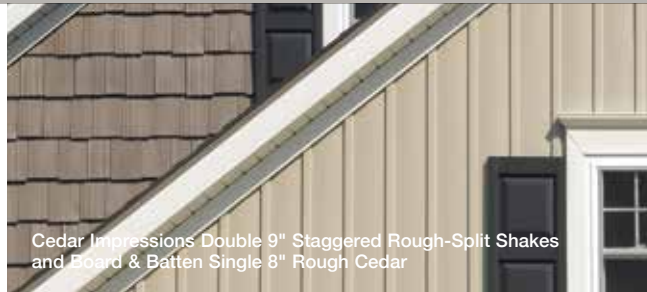

Cedar Impressions Double 9" Staggered Rough-Split Shakes
and Board & Batten Single 8" Rough Cedar

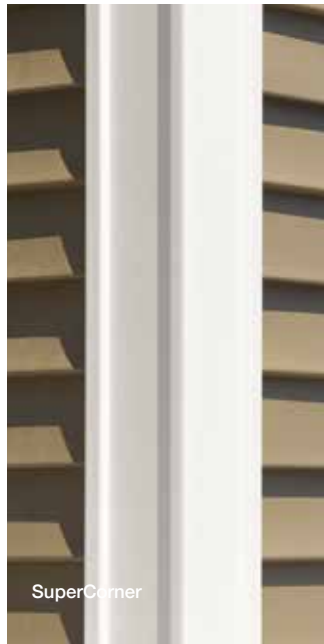

SuperCorner

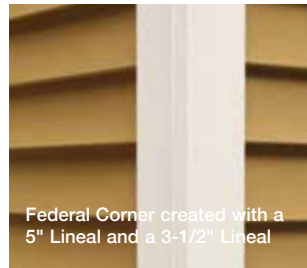

Federal Corner created with a
5" Lineal and a 3-1/2" Lineal



Cornice Molding



Crown Molding
with 3-1/2" Lineals



Cedar Impressions Single 6-1/3"
Perfection Octagon in Autumn Red



Vinyl Carpentry®

Vinyl Carpentry trim offers you a wide array of decorative design possibilities to accent your home's exterior. Replicate the look of real wood with a wonderful assortment of styles and colors – and they never need painting.

- Designed to add distinction to windows, doors, corners, gables and frieze boards.
- Authentic painted wood look.
- New construction and remodeling installation flexibility.
- Wide variety of colors to coordinate with siding.
- Color-clear-through construction means scratches won't show.
- Virtually maintenance free, never needs painting.

Create the look of true wood craftsmanship with a complete line of decorative accents and trim pieces for both new construction and remodeling.

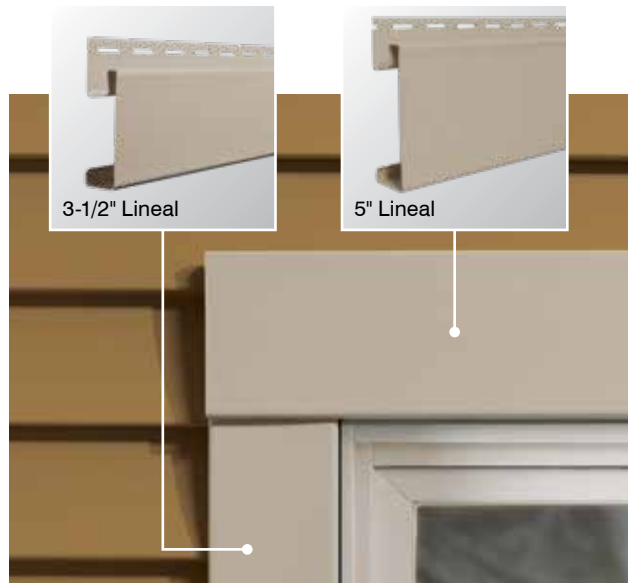

Window & Door Trim

- Crown Molding
- J-Channels
- Lineals



Corner Systems

- Outside Corner Posts
- Insulated Corner Posts
- Inside Corner Posts
- Mitered Corner Posts
- SuperCorners™
- Bay Window Corner Posts



Accents

- Cedar Impressions®
- Northwoods®
- Board & Batten



Wall & Soffit Transitions

- Cornice Molding
- Finish Board
- Band Board
- Double Channel Lineal
- H-Bars
- Lineals

Restoration Millwork®

Exterior Trim

The Ultimate Finish!

- Superior quality and excellent dimensional accuracy.
- Low-maintenance and long-lasting UV-resistant material.
- Natural white and ready to install.
- Can be painted* to complement exterior colors.
- Cuts and mills with traditional woodworking tools.
- Class A (Class 1) Flame Spread Classification.
- Meets ICC and CCMC code requirements.
- Made in U.S.A.
- Contains recycled content.
- 25-year limited warranty.

*See Installation Guidelines RM003 for painting instructions.



InvisiPro® Hidden Fastening System

Trimboards feature grooved millwork that precision-fits to flanges secured directly to the wall, working together with both nail hem flange and starter flange for a secure fit. The flanges are concealed, leaving only a face nail-free installation with no nail holes to fill.

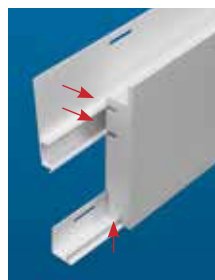

INhanced® TRIM LINE

INspired designs that enhance aesthetics. INnovative engineering that improves performance. INtegral components that speed installation. This collection of decorative components delivers extraordinary advantages from the inside out. Hidden flanges, built-in J-pockets, pre-assembled column wraps and one-piece corners enable easy installation, while authentic finishes create an incredible natural wood appearance.



Look for the IN to identify CertainTeed's INhanced products.

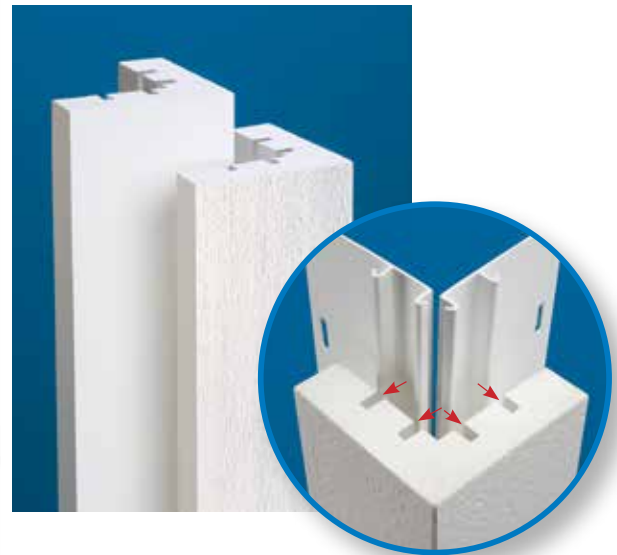

One-Piece Corner and Nail Hem Flange



Corners are now designed to be installed with or without a nailing flange. As part of the InvisiPro Hidden Fastening System, a nailing flange is a quick and easy way of securing corners – avoiding any face nailing of the corner.

- Hidden attachment points.
- Secures tightly to wall with screws.
- Installs before siding.
- Corners can still be used without flange.
- Included on all One-Piece Corners.

Specialty Profiles



Column Wraps

Slides On, Swings Closed for Fast, Easy Installation

A three-sided wrap with a swinging door on the fourth side, Column Wraps are pre-cut and pre-mitered, to slide around existing wood load-bearing 4 in. x 4 in. or 6 in. x 6 in. porch posts.

Simple and versatile, with 2 column sizes: 8 in. x 8 in. and 10 in. x 10 in. square.



J-Pockets and Cut-Outs

Restoration Millwork trimboards with built-in J-pocket eases installation of corner trim and the cut-out allows the trimboard to lie flush with the siding around windows and doors with built-in nail flanges.

Fascia Trimboard

Fascia trimboard with built-in return leg is designed to work with a wide range of soffit materials. Available in TrueTexture™ and smooth finish.

Skirtboard with DualStart® Design

Engineered with DualStart Design (patent-pending) cuts installation time while providing the 6 in. ground clearance required by U.S. building codes for fiber cement siding.

Beadboard with TightLap™

Whether you choose 2TL or 3TL, Beadboard with TightLap is designed to have a larger nailing area with the security of tongue and groove.

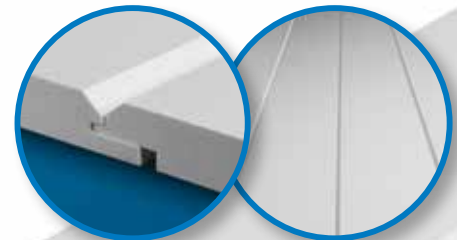

WP4 with TightLap™ and Nickel Gap (on reverse)



Beadboard with TightLap™

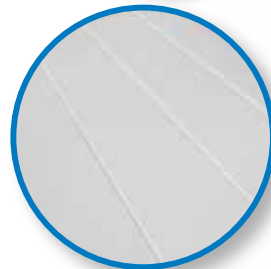

Beadboard 2TL and 3TL are Reversible



3TL Beadboard—a full 1/3 wider for faster coverage.

Sheets

Available in a full selection of custom and standard sizes and shapes, sheets can be used to create distinctive, one-of-a-kind exterior elements that are as beautiful as they are durable.



CustomCraft™

Restoration Millwork sheets and boards custom fabrication feature extra thickness, so they reduce time and labor costs related to laminating and creating custom designs. Available in half units only.



Finishing Touches



J-Channel



3-1/3" Cornerpost

Good



Siding: CedarBoards™ Single 7" Clapboard in Sterling Gray.

Trim: Vinyl Carpentry® in Colonial White and Sterling Gray.

Roofing: Landmark® Shingles in Georgetown Gray.

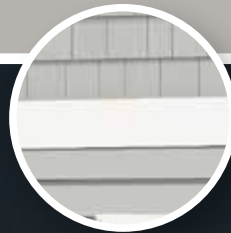

Restoration Millwork trimboard*



3-1/2" Lineal with miter cut corners



3-1/3" Cornerpost

Better



Siding: CedarBoards Single 7" Clapboard and Board & Batten Single 8" in Sterling Gray with Cedar Impressions Double 7" Straight Edge Perfection Shingles in Charcoal Gray.

Trim: Vinyl Carpentry® & Restoration Millwork® in Colonial White.

Roofing: Landmark Shingles in Georgetown Gray.

Details Create the Personality

Here are just a few of many ideas for finishing gables, windows, corners, columns, railings, porches and more. With CertainTeed exterior products, there are no limits to the unique personality you can create. And by adding just the right balance of details, you are improving the curb appeal and value of your home.



Oxford railing with square balusters in white



Restoration Millwork Classic Column Wraps

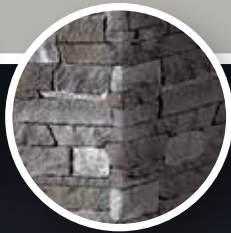

STONEfaçade™ Corners

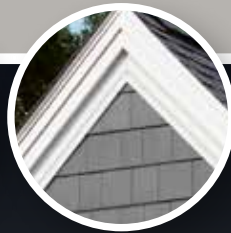

Vinyl Carpentry Cornice Molding and Restoration Millwork Rake Profile



Restoration Millwork Trimboard with Rams Crown



Restoration Millwork One-Piece Corner with InvisiPro Hidden Fastening System

Best



Siding: CedarBoards Single 7" Clapboard in Sterling Gray and Cedar Impressions Double 7" Straight Edge Perfection Shingles in Charcoal Gray with STONEfaçade in Adirondack Snowfall.

Trim: Vinyl Carpentry® & Restoration Millwork® in Colonial White.

Roofing: Landmark Shingles in Georgetown Gray.

CertaWrap™

Weather Resistant Barrier



Moisture
Resistant



STUDfinder



CertaTape™



available in 1-7/8" x 165'

CertaWrap Accessories

For maximum effectiveness, it's critical to finish your CertaWrap installation with tight sealing methods. CertaWrap accessories offer everything needed to get the job done right. Use them to seal window and door openings, cracks, seams and penetrations prior to applying exterior cladding.

CertaWrap Weather Resistant Barriers, in premium or standard grade, provide an added layer of protection against air and moisture damage. It's part of the complete CertainTeed Weather Deterrence Wall System.

- The best defense against mold, mildew and water damage.
- Superior air holdout for better energy efficiency.
- Optimal Permeance Rating of **11.7 (Premium)**
Optimal Permeance Rating of **12-15 (Standard)**
- Outstanding UV performance.
- Excellent surfactant resistance.
- Double-strength tear resistance.
- Easy handling and installation with STUDfinder™.
- Class 1(A) fire rating
- Lifetime limited warranty.
- Available co-branded with your logo!

Moisture Technology, inside and out

Beauty is more than skin deep. That's especially true when it comes to building or improving a home. Moisture protection, energy efficiency and long-term performance are just as important as aesthetics. The CertainTeed Weather Deterrence Wall System delivers those advantages. As a key component in the system, CertaWrap Weather Resistant Barrier provides protection from the elements, and helps assure long-term satisfaction.

The CertainTeed Weather Deterrence System

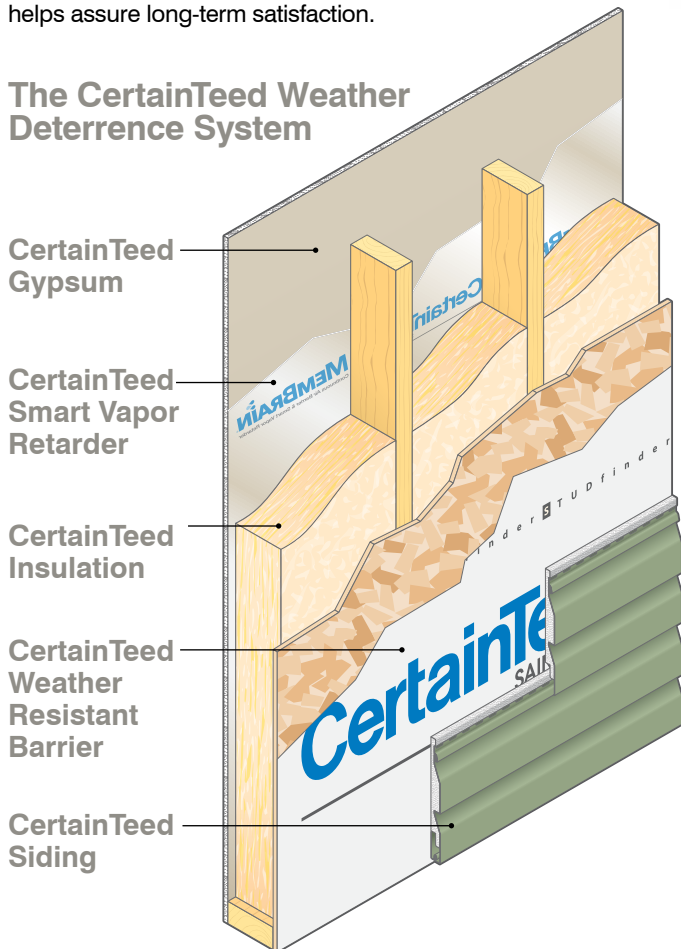

CertaWrap Premium Weather Resistant Barrier Performance

Superior Breathability, Water Resistance and Vapor Transmission

Mold, mildew and water damage are a home's worst enemies. An effective weather barrier system defends against these problems by resisting moisture penetration and air infiltration while allowing water vapor to dissipate. CertainTeed CertaWrap offers the industry's best combination of all of these properties, helping you defend against moisture and the elements during construction, and preventing moisture buildup – from inside and outside the home – after cladding is applied.

CertaWrap is available in the following roll dimensions:	Premium	Standard
	3' x 100'	9' x 100'
	3' x 165'	
	4.5' x 200'	
	5' x 200'	
	9' x 100'	
	9' x 150'	

CertaWrap Standard Housewrap

CertaWrap Standard Housewrap is a coated poly woven fabric for use in housewrap applications that controls airflow through the wall and protects against outside water from penetrating the exterior of a home. It is engineered to resist water while allowing water vapor to pass through and is stabilized to resist degradation.

EverNew[®]

Oxford & Kingston Vinyl Railing Systems





Extend your living space with railings that offer both design aesthetics and performance.

Railing: Kingston in White with aluminum balusters.

Details Matter

Aluminum reinforced rails, precision-fit components and a wide variety of finishing accessories offers beautiful options and unmatched performance.



Kingston & Oxford BRACKETED Systems

Aluminum rail mount brackets provide a safe and secure metal-to-metal, rail-to-post connection for greater strength and longevity.

Kingston

- Classic bread-loaf rail design for both top and bottom rails.
- Available in two heights and three lengths.
- Independent tested as designated in report CCRR-0211.
- Suitable for one- and two-family dwellings and townhouses not more than three stories high.
- Lifetime limited warranty with 5-year SureStart™ protection.
- Available in three colors: white, almond and clay

Oxford

- “T”-rail top and 2x4 bottom rail system.
- Available in two heights and three lengths.
- Independent tested as designated in report CCRR-0187.
- Suitable for residential and commercial applications – including multifamily and over three story installations.
- Lifetime limited warranty with 5-year SureStart™ protection.
- Available in white.



Powder-coated round aluminum balusters now offered in Oxford and Kingston



Kingston Railing with square balusters in White.



Kingston Railing with traditional balusters in White. Also shown 8" tapered round structural column.



Oxford Railing with classic balusters in White.



Oxford ROUTED System

The ultimate in beauty, safety and performance.

- "T"-rail top and 2x4 bottom rail system.
- Available in two heights and three lengths.
- Independent tested as designated in report CCRR-0187.
- Suitable for residential and commercial applications – including multifamily and over three story installations.
- Lifetime limited warranty with 5-year SureStart™ protection.
- Available in white.

Everything you need to make your vinyl railing project a success

Available Colors*

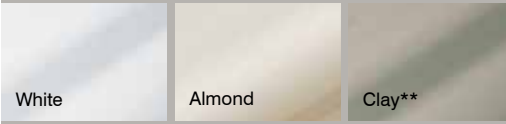

*Not all colors available in all styles

**ColorLast® Dark Color Fade Protection - Our acrylic formulation provides superior protection from the harsh rays of the sun, resulting in richer color that retains its vibrant hue for years to come. ColorLast is offered in clay.

EverNew Gate Kits

EverNew gates feature a heavy-duty internal aluminum frame for sturdy construction that's built to last and stainless steel fasteners to prevent corrosion. Kits include hinges and latch.



Decorative Post Caps and Solar Lighting

For complete details, refer to CertainTeed's EverNew Decking & Railing Systems brochure (code # 40-70-425).

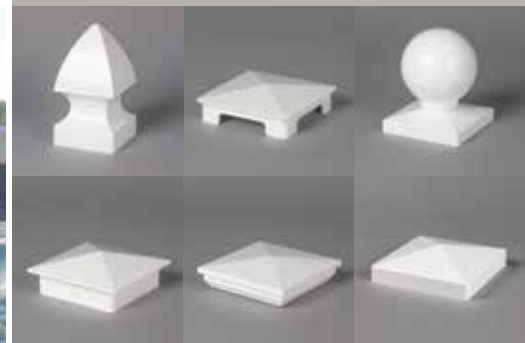

Oxford Railing in White with round aluminum balusters.



Oxford Railing in White with clear glass balusters.



CertainTeed products are designed to work together and complement each other in color and style to give any home a beautiful, finished look.



POLYMER SHAKES & SHINGLES



VINYL SIDING



INSULATED SIDING



SOFFIT



PVC EXTERIOR TRIM & BEADBOARD



VINYL CARPENTRY® TRIM



STONE



HOUSEWRAP



ROOFING AND VENTILATION



DECKING AND RAILING



MOLDED FENCE



EXTRUDED FENCE



facebook.com/certainteed



[YouTube youtube.com/certainteedsaintgobain](https://youtube.com/certainteedsaintgobain)



CertainTeed

CEILING • DECKING • FENCE • GYPSUM • INSULATION • RAILING • ROOFING • SIDING • TRIM
20 Moores Road, Malvern, PA 19355 Professional: 800-233-8990 Consumer: 800-782-8777 certainteed.com

©01/22 CertainTeed, Printed in the USA, Code No. 04-00-20-NA-EN